



OmniLogic®

Automation and Chlorination

Installation Manual



The image shows the OmniLogic HLBASE unit, a grey metal cabinet with a control panel on top. To the left of the unit is a wall-mounted control panel with a digital display and buttons. In front of the unit are a tablet and a smartphone, both displaying the OmniLogic mobile application interface.

Contents

- Before You Begin.....1
- Overview.....1
- Mounting Equipment.....4
- Plumbing.....6
- Electrical Wiring.....10
- Preparing Pool/Spa Water.....20
- System Startup.....23
- Configuration.....23
- Warranty.....45

HLBASE

Hayward Industries
1415 Vantage Park Dr., Suite 400
Charlotte, NC 28203
Phone: (908) 355-7995
www.hayward.com



HAYWARD®

IMPORTANT SAFETY INSTRUCTIONS

When using this electrical equipment, basic safety precautions should always be followed, including the following:

- **READ AND FOLLOW ALL INSTRUCTIONS**
- **WARNING:** Disconnect all AC power during installation.
- **WARNING:** Water in excess of 100 degrees Fahrenheit may be hazardous to your health.
- **WARNING:** To reduce the risk of injury, do not permit children to use this product unless they are closely supervised at all times.
- **WARNING:** Do not use the OmniLogic to control fire pits or related fire equipment.
- A green colored terminal marked “Grounding” is located inside the wiring compartment. To reduce the risk of electric shock, this terminal must be connected to the grounding means provided in the electric supply service panel with a continuous copper wire equivalent in size to the circuit conductors supplying the equipment.
- One bonding lug for US models is provided on the external surface. To reduce the risk of electric shock, connect the local common bonding grid in the area of the swimming pool, spa, or hot tub to these terminals with an insulated or bare copper conductor not smaller than 8 AWG US / 6 AWG Canada.
- All field installed metal components such as rails, ladders, drains, or other similar hardware within 3 meters of the pool, spa or hot tub shall be bonded to the equipment grounding bus with copper conductors not smaller than 8 AWG US / 6 AWG Canada.
- **SAVE THESE INSTRUCTIONS**



FCC Statement

This device complies with part 15 of the FCC rules. Operation is subject to the following two conditions: (1) This device may not cause harmful interference, and (2) this device must accept any interference received, including interference that may cause undesired operation.

Changes or modifications not expressly approved by Hayward could void the user's authority to operate this equipment.

NOTE: This equipment has been tested and found to comply with the limits for a Class B digital device, pursuant to Part 15 of the FCC Rules. These limits are designed to provide reasonable protection against harmful interference in a residential installation. This equipment generates, uses and can radiate radio frequency energy and, if not installed and used in accordance with the instructions, may cause harmful interference to radio communications. However, there is no guarantee that interference will not occur in a particular installation. If this equipment does cause harmful interference to radio or television reception, which can be determined by turning the equipment off and on, the user is encouraged to try to correct the interference by one or more of the following measures:

- Reorient or relocate the receiving antenna.
- Increase the separation between the equipment and receiver.
- Connect the equipment into an outlet on a circuit different from that to which the receiver is connected.
- Consult the dealer or an experienced radio / TV technician for help.

Industry Canada Statement

This Class B digital apparatus complies with Canadian ICES-003.

Cet appareil numérique de la classe B est conforme à la norme NMB-003 du Canada.

The term "IC" before the certification / registration number only signifies that the Industry Canada technical specifications were met.



Table of Contents

Introduction	Installation Steps.....	3
Preparing Mounting Equipment	OmniLogic Wiring Panel.....	4
	Control Pad.....	5
	Temperature Sensors.....	5
	Optional Chlorination.....	5
	Optional HL-CHEM Sensing Kit.....	5
	Optional AQL-CHEM2 pH Dispensing.....	5
	Optional HLWALLMOUNT.....	5
	Optional Valve Actuators.....	6
Plumbing	Pool/Spa Configuration.....	6
	TurboCell.....	9
	Flow Switch.....	9
Electrical Wiring	Main Service.....	11
	Grounding and Bonding.....	11
	Circuit Breaker Installation and Wiring.....	11
	General Purpose Outlet.....	11
	OmniLogic Power.....	11
	Pool Equipment Connection Table.....	12
	High Voltage Pool Equipment.....	13
	Low Voltage Wiring.....	14
Pool/Spa Water	General Water Chemistry.....	20
	Salt.....	21
Final Steps	System Startup.....	23
Startup and Configuration	Startup and Configuration Wizard.....	23
	Bodies of Water.....	25
	Filter Pumps.....	25
	Heaters.....	26
	Chillers.....	28
	HL-CHEM.....	29
	Chlorinator.....	29
	Cleaners.....	30
	Water Features.....	31
	Lights.....	32
	Accessories.....	32
	Shared Equipment.....	33
	Sensors.....	34
	Backyard Accessories.....	35
	Interlocks.....	35
	Quick Edit.....	36
Warranty	OmniLogic Limited Warranty.....	45



Before you Begin

What's Included

Before attempting to install the OmniLogic system, check that the following components have been included in the package:

- OmniLogic Wiring Panel
- OmniLogic Control Pad
- (3) Temperature sensors with 15 ft. (5m) cable, hose clamp
- Spare main board fuses

What's NOT Included

Some of the additional items that you may need to complete an installation include:

Circuit breakers - None are included with control—see page 11 and inside door label for suitable breakers

Wire

- 4-conductor cable for connection to optional wired terminal(s)
- Wire/conduit for 100A service from main panel to OmniLogic
- Wire/conduit for filter pump and other high voltage loads
- Wire for remote heater control and other low voltage devices
- Wire for bonding

Miscellaneous

- Optional utility electrical outlet and weatherproof cover (for mounting on lower right side of OmniLogic)
- Mounting hardware (screws, bolts, etc.) for mounting OmniLogic and remote terminals
- Valve Actuators (to automate valve functions)

Accessory Products - Order Separately

HLEXPAND	Expansion Panel
HLH485RELAY	Smart Relay
HLRELAYBANK	Additional relay pack adds 4 high voltage relays
HLRELAY	Single high voltage relay kit
HLIOEXPAND	Input/Output Expander Board adds 4 additional sensor/external inputs, 4 heater/low voltage outputs, and 4 actuator outputs
HLWALLMOUNT	Wired Wall Mount Remote Terminal
HLWIRELESS	Portable Wireless Remote Terminal
HLSPASIDE	Wired Spa Remote
HL-CHEM	ORP & pH Sensing Kit for monitoring and controlling pool chemistry
AQL-CHEM2	CO ₂ Dispenser
TCELLS340	Chlorinator Cell - generates chlorine for pools up to 40k gallons
TCELLS325	Chlorinator Cell - generates chlorine for pools up to 25k gallons
TCELLS318	Chlorinator Cell - generates chlorine for pools up to 18k gallons
TCELLS315	Chlorinator Cell - generates chlorine for pools up to 15k gallons
P-KIT	Chlorination plumbing kit containing flow switch and cell unions
HL-CHEM4-ACID	Liquid acid feeder
HL-CHEM4-CHLOR	Liquid chlorine feeder
CL200	Chlorine tablet feeder
GVA-24	Valve Actuator
V&A-xx	Valve & Actuator (xx=1P (1.5" pos. seal), -2P (2" pos. seal))

NOTE: Before installing this product as part of a saline water purification system in a pool or spa using natural stone for coping or for immediately adjacent patios/decking, a qualified stone installation specialist should be consulted regarding the appropriate type, installation, sealant (if any) and maintenance of stone used around a saline pool with an electronic chlorine generator in your particular location and circumstances.

NOTE: The use of dry acid (sodium bisulfate) to adjust pool pH is discouraged especially in arid regions where pool water is subject to excessive evaporation and is not commonly diluted with fresh water. Dry acid can cause a buildup of by-products that can damage your chlorinator cell.

Overview

The functions and features described in this manual assume that the OmniLogic is using the latest firmware version available from Hayward. The OmniLogic HLBASE is a multifunction pool automation control that is expandable to meet all your needs and fully manage your pool/spa system. The OmniLogic can control pumps, valves, lighting, heaters, pool chemistry and more. It offers the next generation of technology to manage pool/spa equipment and the backyard experience. Using a touchscreen interface and network connectivity, the OmniLogic gives the user complete control over both automation and chlorination of their pool and spa. Although the OmniLogic is easy to use, it is important to completely read through this manual before attempting to install, configure or operate the unit.



Features

The standard Hayward OmniLogic HLBASE offers the following features:

- control up to 4 (expandable to 10) high voltage (120/240V) relays to control pumps, pool lights, yard lights, water features, chemical dispensers and more
- control up to 4 (expandable to 8) automatic valve actuators including pool and spa valves, water feature valves, cleaner valves and more
- control up to 4 (expandable to 8) heaters or low voltage equipment including gas heaters, electric heat pumps, and chillers as well as various low voltage devices
- controls up to 16 compatible variable speed pumps and Smart Heaters without the use of a relay
- inputs for up to 4 temperature sensors or external input devices (expandable to 8)
- both wireless and wired access are available to the home's router/access point allowing communication to devices on the home network or on the web
- 100A electrical subpanel that can accommodate up to 12 circuit breakers
- connection for Hayward TurboCell used to generate chlorine
- connection for flow switch used to detect water flow
- input for ORP and pH sensing (HL-CHEM)
- control an optional Hayward Aqua Rite salt chlorinator for additional chlorination. If controlled by the OmniLogic, the Aqua Rite must have a HLAQRPCB communication board installed (some models)
- connection for Expansion Panel if more than one OmniLogic is required

Optional accessories (page 1) can expand the functionality of the HLBASE. Determine your needs and select the necessary HLBASE accessories before you begin the installation.

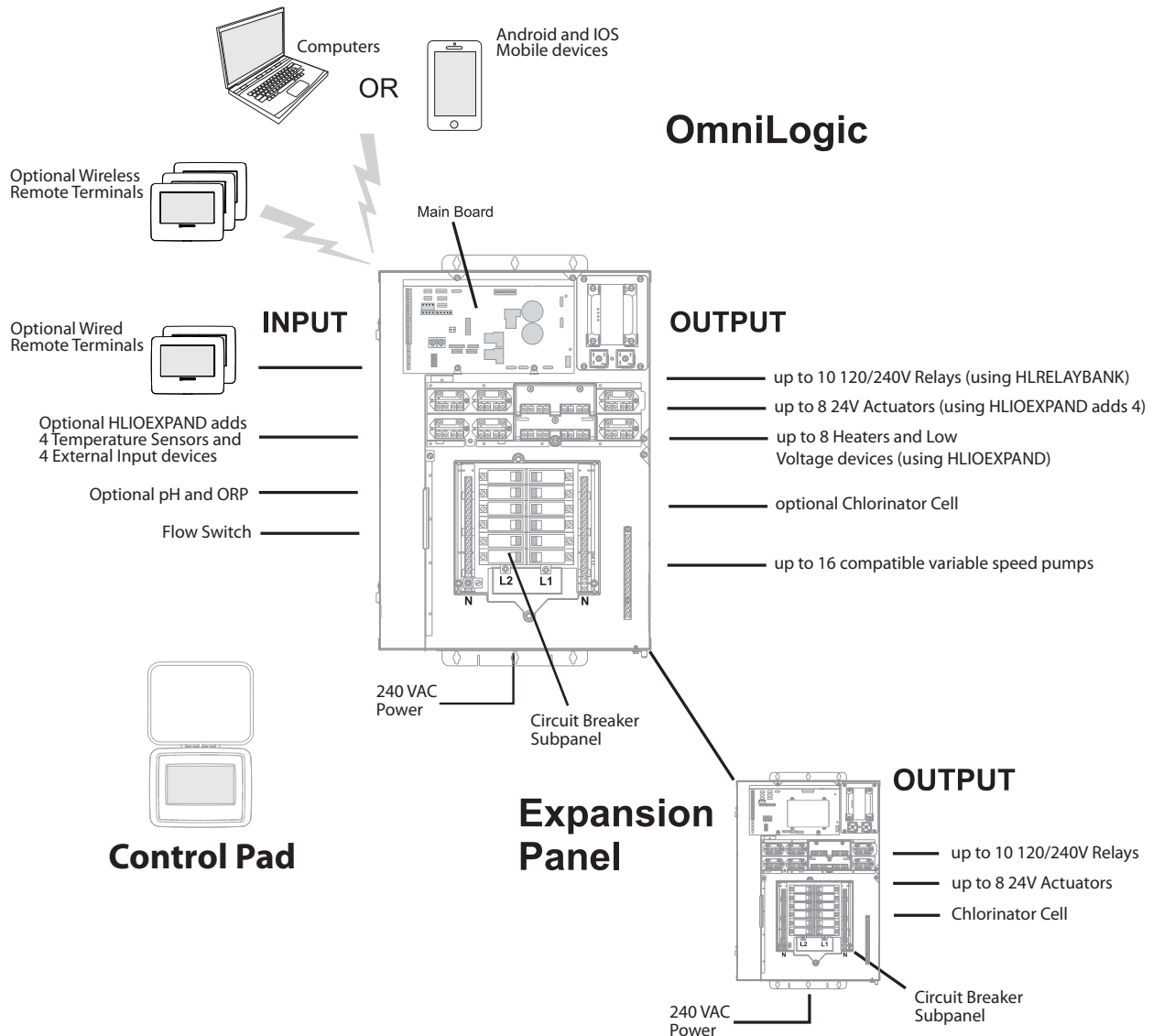



Installation Steps

DANGER of Death, Injury or Property Damage if procedure not followed. Dead front removal is required for this installation. Power to the OmniLogic panel **MUST** be shut off before the dead front is removed. This means a complete shutdown of power to the entire OmniLogic panel.

Details on each installation step are presented on the following pages:

1. Mounting the equipment (page 4)
 - OmniLogic Wiring Panel
 - OmniLogic Control Pad
 - Temperature sensors
 - Remote display/keypad (optional)
 - Valve actuators (if applicable)
2. Plumbing (page 6)
 - General Pool Equipment
 - TurboCell (optional)
 - Flow Switch
3. Electrical Wiring (page 10)
 - Main service
 - Grounding and bonding
 - Circuit breakers
 - OmniLogic power
 - High Voltage pool equipment
 - Low voltage wiring (Control Pad, temperature sensors, flow switch, etc.)
4. Prepare the pool water (page 20)
 - General Water Chemistry
 - Salt
5. System Startup and Firmware Upgrade (page 23)

NOTE: If replacing a Pro Logic Controller using networked ColorLogic Lights, the lights must be put into "Standalone" (default) mode before disconnecting the Pro Logic. The OmniLogic can only control ColorLogic lights in "Standalone" mode.



Mounting the Equipment

OmniLogic Wiring Panel

The OmniLogic is contained in a raintight enclosure that is suitable for outdoor mounting. The control must be mounted a minimum of 6 ft. (2 meters) horizontal distance from the pool/spa (or more, if local codes require). The OmniLogic is designed to mount vertically on a flat surface with the knockouts facing downward. Because the enclosure also acts as a heat sink (disperses heat from inside the box), it is important not to block the four sides of the control. Do not mount the OmniLogic inside a panel or tightly enclosed area.

When selecting a location, note that the standard cables supplied with the included flow switch and temperature sensors, as well as optional accessories like Hayward TurboCells and actuators are all 15 ft. (5m) long. Try to mount the OmniLogic at a height where the touchscreen can be accessed easily.

The OmniLogic weighs close to 60lbs. and will require two people to position and install. Select the proper location and mounting hardware given the size and weight of the unit. The OmniLogic mounting brackets require a total of 6 mounting bolts to fasten the OmniLogic to the mounting surface.

Note that there is a heat sink on the back of the enclosure. Refer to the following information regarding the OmniLogic heat sink:

In all cases the heat sink on the back of the OmniLogic wiring panel should not contact the wall behind the panel. This restricts air flow and makes the heat sink less efficient. A minimum separation of 1/8" (except for vinyl siding) should be maintained between any heat sink pin and the siding on the wall behind the enclosure. In the case of a flat wall the mounting flanges on the enclosure ensure that the minimum clearance is maintained. For shingles, clapboards or other siding with a non-flat profile, the installer must ensure the minimum separation. Refer to the diagram on below.

Special Installation Instructions for Vinyl Siding

IMPORTANT: The heat sink on the back of the OmniLogic wiring panel cannot be allowed to contact vinyl siding; during normal chlorinator operation the heat sink pins get warm enough to deform vinyl siding on contact. An increased minimum separation of 3/8" should be maintained between any heat sink pin and the vinyl siding behind the enclosure.

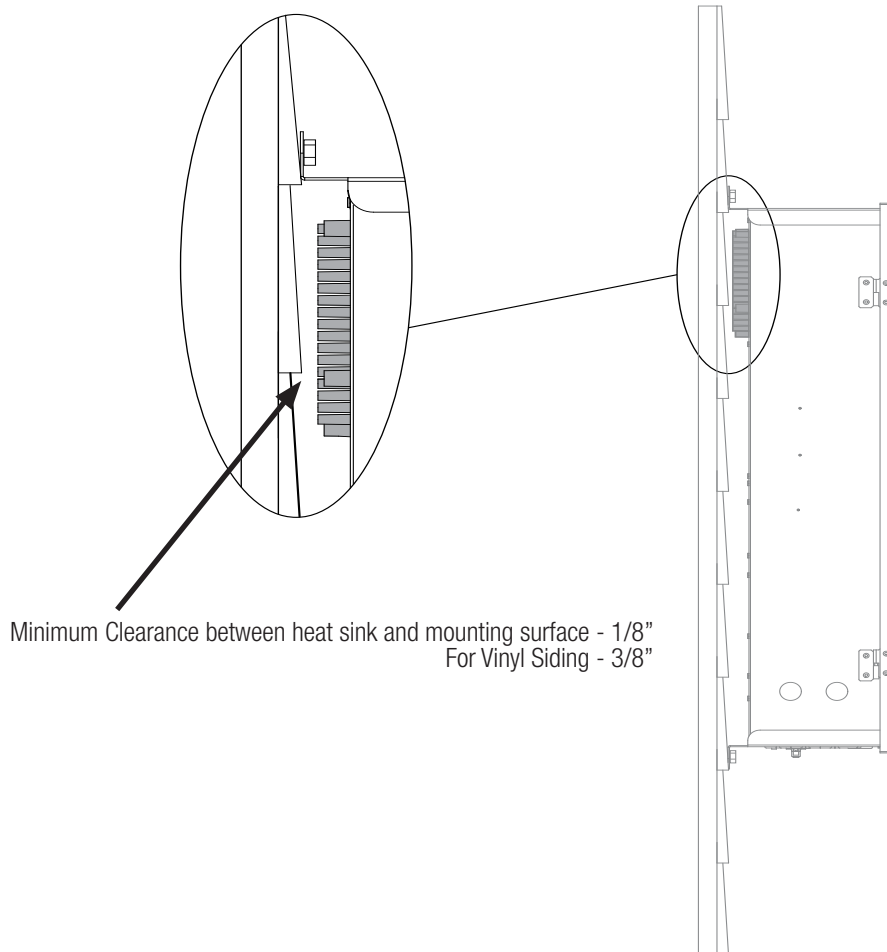



OmniLogic Control Pad

The Control Pad comes with a 15 ft. cord and plugs into the wiring panel. It should be mounted in a location that is convenient for the user to view and change pool/spa settings. When considering the mounting location, make sure there is enough clearance above the enclosure so that the flip door is able to be opened fully. Also be sure to allow enough clearance below the Control Pad to access the Ethernet connector if used. For best viewing results, position the Control Pad where it won't be subjected to direct sunlight.

The Control Pad has two keyhole cutouts on the back of its enclosure. To mount, screw two fasteners (not provided) into the mounting surface at the desired location as shown. A mounting template can be found on page 44 of this manual. Tighten until the bottom of the screw heads are 1/8" off the mounting surface. Position the Control Pad cutouts over the screw and slide the unit downward. You may have to tighten or loosen the screws slightly to fully engage the screw heads to get a snug fit.

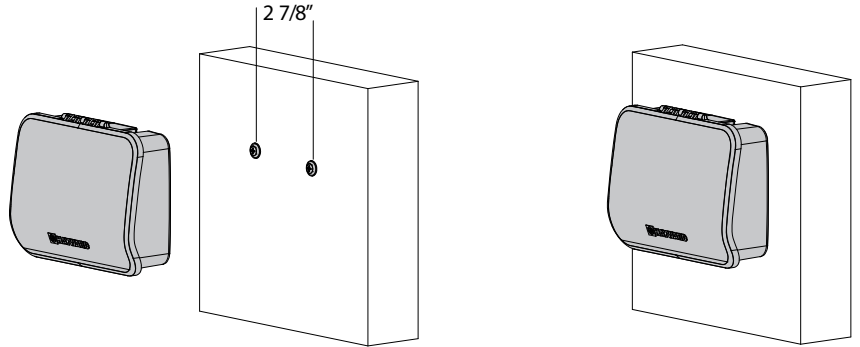

Temperature Sensors

Three sensors are included with the OmniLogic. A water sensor and an air sensor must be installed at all times for proper operation. A solar sensor is required if the solar function is enabled.

Water Sensor

This sensor is used to measure the pool/spa temperature and is installed in the filtration plumbing after the filter but before either the solar or conventionally fueled heaters—refer to the plumbing overview diagram.

1. Drill a 3/8" (10mm) diameter hole in the PVC piping and remove all chips and burrs.
2. Insert sensor until O-ring collar sits flush on the hole.
3. Position hose clamp over the sensor and gently tighten until O-ring makes an adequate seal. Do not overtighten.

Air Sensor

Mount the air sensor outdoors. **IMPORTANT:** The air sensor must not be mounted in direct sunlight.

Solar Sensor

For solar applications, mount the sensor near the solar collector array so that it is exposed to the same sunlight as the collectors. Use additional cable (20 AWG) if necessary.

Optional Chlorination Function

This OmniLogic model requires the use of a chlorinator cell and plumbing kit to provide pool chlorination. These items are not included with the OmniLogic and can be purchased separately at your local Hayward dealer. Choose a chlorinator cell model based on the size of your pool; models are shown below. In addition to the chlorinator cell, a plumbing kit (P-KIT) must be purchased. This kit contains the cell unions and flow switch. Refer to pages 9 and 20 for plumbing and wiring instructions.

- TCELLS340 (for pools up to 40k gallons)
- TCELLS325 (for pools up to 25k gallons)
- TCELLS318 (for pools up to 18k gallons)
- TCELLS315 (for pools up to 15k gallons)

Optional HL-CHEM Sensing Kit

The HL-CHEM is an ORP and pH sensing kit for the OmniLogic. When chlorination is enabled (requires chlorinator cell, liquid chlorine feeder or tablet feeder), the OmniLogic senses the pool's ORP and pH levels and generates/dispenses the correct amount of chlorine to keep your pool properly sanitized. Wiring and plumbing requirements for the HL-CHEM should be considered before installing the OmniLogic. Refer to the HL-CHEM manual for specific installation information. **NOTE:** OmniLogic is not compatible with AQL-CHEM.

Optional AQL-CHEM2 CO2 Dispensing Kit

The AQL-CHEM2 is a CO2 dispensing device that connects directly to the OmniLogic. When used with an HL-CHEM, the OmniLogic will sense the pool's pH level and automatically dispense the correct amount of CO2 to control the pool's pH to the desired level. Wiring and plumbing requirements for the AQL-CHEM2 should be considered before installing the OmniLogic. Refer to the AQL-CHEM2 manual for specific installation information.

Optional Remote Terminals

Hayward offers an optional wired remote terminal (HLWALLMOUNT) for fixed surface mounting as well as a wireless remote terminal (HLWIRELESS) for portable convenience. Both give you the ability to control your pool's functions from a remote location, away from the pool pad. The OmniLogic can also be controlled remotely by various internet enabled devices such as phones, tablets and PCs.

HLWALLMOUNT

The HLWALLMOUNT is a wired touchscreen remote terminal designed to be mounted up to 500' away (depending on cable gauge) from the OmniLogic. The HLWALLMOUNT must be mounted indoors or in a weather protected area (rain should never touch the unit). It can mount over a single gang electrical utility box or can be mounted directly onto any wall surface. When selecting a mounting location, refer to the HLWALLMOUNT manual for more information. Up to two HLWALLMOUNTS can be connected to the OmniLogic.

Optional Valve Actuators

For optional actuators used with the OmniLogic—note that the internal cams in the actuator may also have to be adjusted depending on the way the actuator is mounted on the valve and the desired valve action.

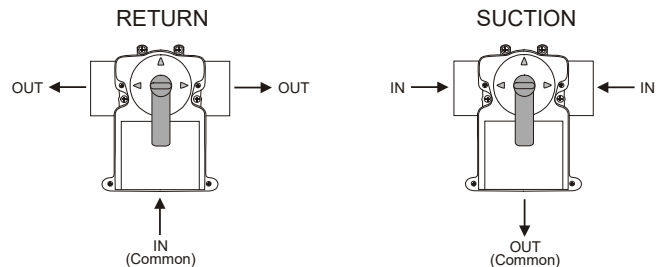

Plumbing

Pool/Spa System Configuration

These systems use a single filter pump and filter. Pool or spa operation is controlled by two 3-way valves (suction and return). Refer to the diagram below.

High Voltage Relays	Valve Outputs
Filter Pump	Pool/Spa Suction
Lights	Pool/Spa Return
Aux 1	Valve 3
Aux 2	Valve 4

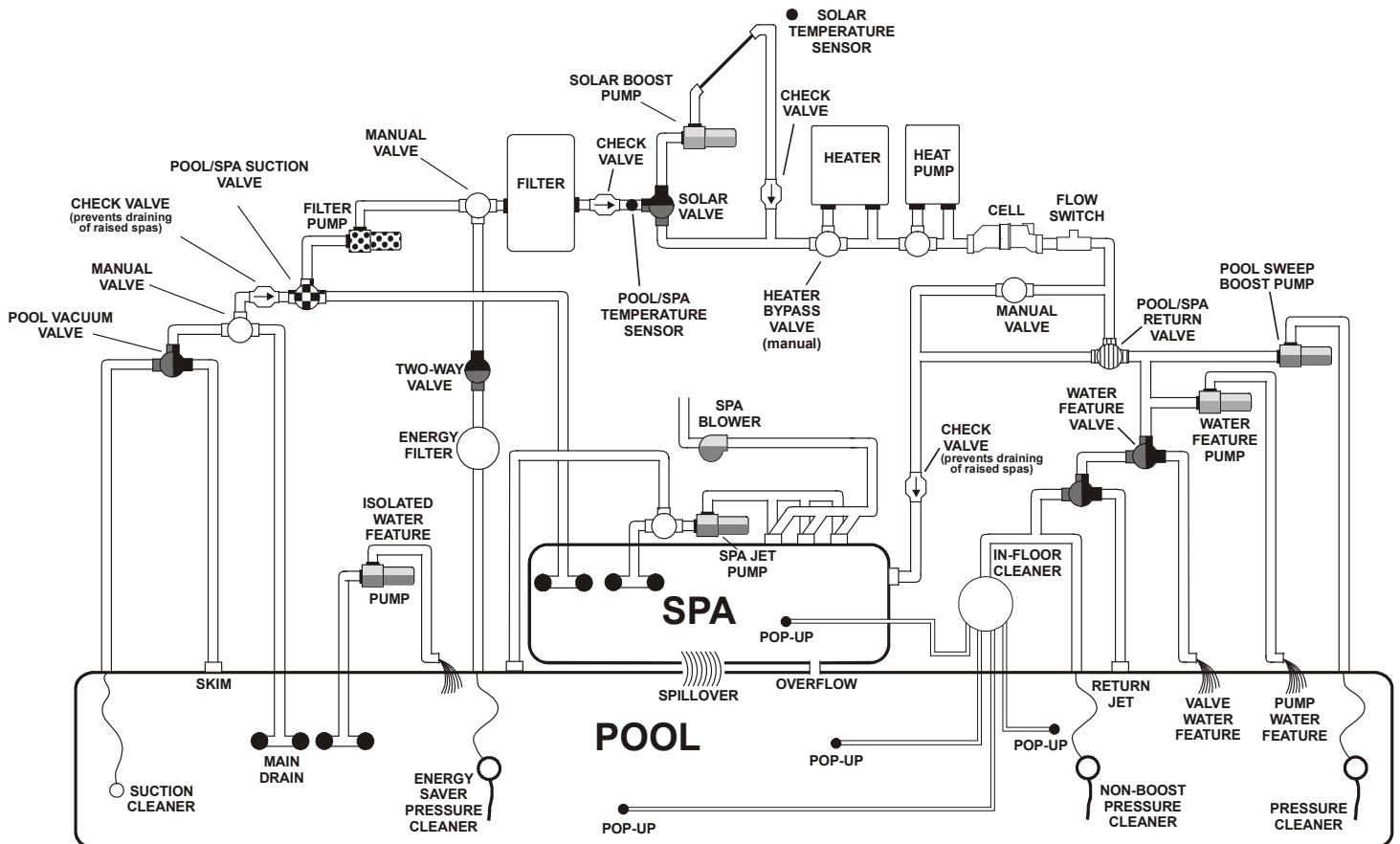
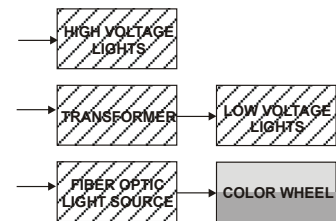

4. The OmniLogic can be programmed to accommodate spillover if desired. Note that spillover operation will be automatically suspended whenever the spa filter pump is turned on.
5. The chlorinator cell must be installed in the pool plumbing. If spillover is enabled, then the OmniLogic can chlorinate both the pool and spa (during spillover operation). Otherwise, the OmniLogic will only chlorinate the pool and the spa sanitization will have to be handled manually.
6. If any water feature or pressure side cleaner boost pumps are used, be sure to enable the “interlock” feature (see CONFIGURATION for details) to ensure that the pumps operate only when the “Pool Filter” pump is on and the system is in the “pool only” operating mode.
7. The plumbing diagram on page 6 is intended to be used as a general guideline and is not a complete plumbing schematic for the pool.

“Dual Equipment - Shared Heaters” for Pool/Spa Configuration

These systems have 2 complete sets of equipment (filter pump, filter) and shared heaters. Refer to the diagram below:

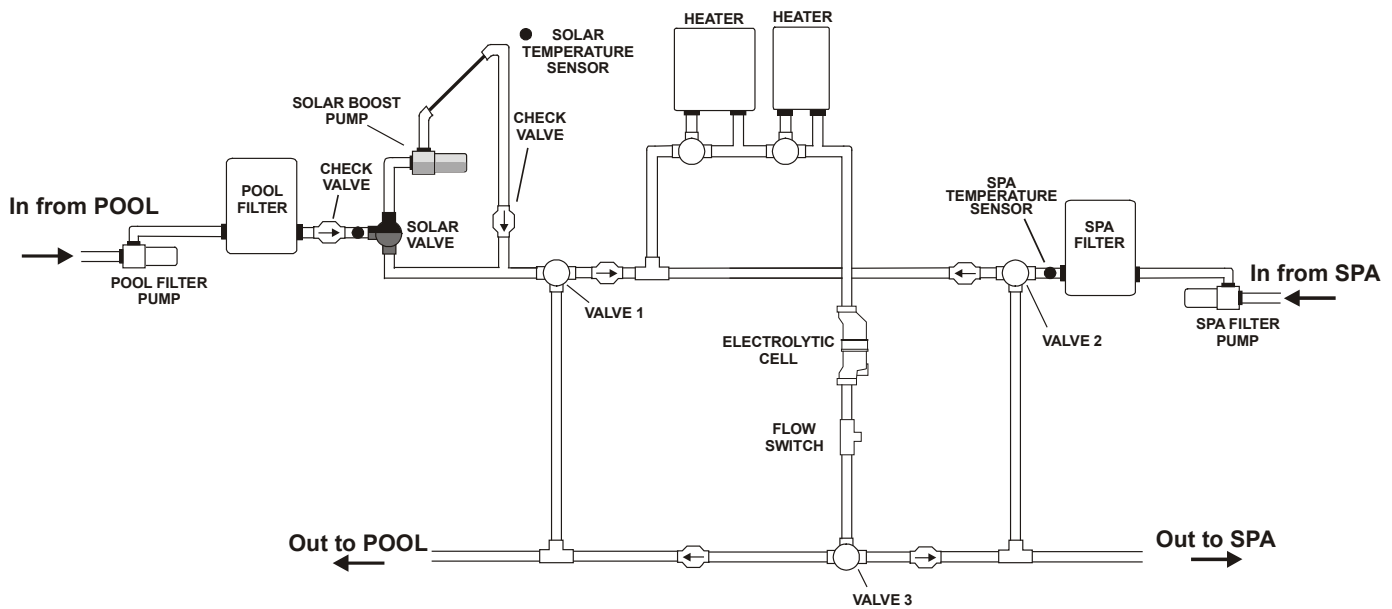

Some important notes regarding the control of Dual Equipment Pool/Spa systems with shared heaters:

In the Pool/Spa Config., select:

1. When the system is configured for Dual Equipment:
 - a. The pool filter can be a one, two or variable speed pump.
 - b. The spa filter can be a one, two or variable speed pump.
 - c. The heater(s) will be dedicated to the spa whenever the spa filter is on and the spa temperature setting is not off.
2. The water sensor should be installed on the pool loop prior to the heater(s) and will display the pool temperature whenever the “Pool Filter” pump is running.
3. The dual equipment spa sensor should be installed on the spa loop prior to the heater(s) and will display the spa temperature whenever the “Spa Filter” pump is running.
4. The OmniLogic can be programmed to accommodate spillover if desired. Note that spillover operation will be automatically suspended whenever the spa filter pump is turned on.
5. The chlorinator cell and flow switch must be installed in the heater return path. If spillover is enabled, then the OmniLogic can chlorinate both the pool and spa (during spillover operation). Otherwise, the OmniLogic will only chlorinate the pool when the spa does not control the heater(s) and the spa sanitization will have to be handled manually.
6. If any water feature or pressure side cleaner boost pumps are used, be sure to enable the “interlock” feature (see CONFIGURATION for details) to ensure that the pumps operate only when the “Pool Filter” pump is on and the system is in the “pool only” operating mode.
7. The plumbing diagram on page 6 is intended to be used as a general guideline and is not a complete plumbing schematic for the pool.



Optional TurboCell

The TurboCell (used for chlorine generation) must be plumbed AFTER the filter and heater. If installed on a pool/spa combination system, the cell must be plumbed BEFORE the pool/spa return valve in order to allow proper chlorination of both the pool and the spa. Refer to plumbing diagram below:

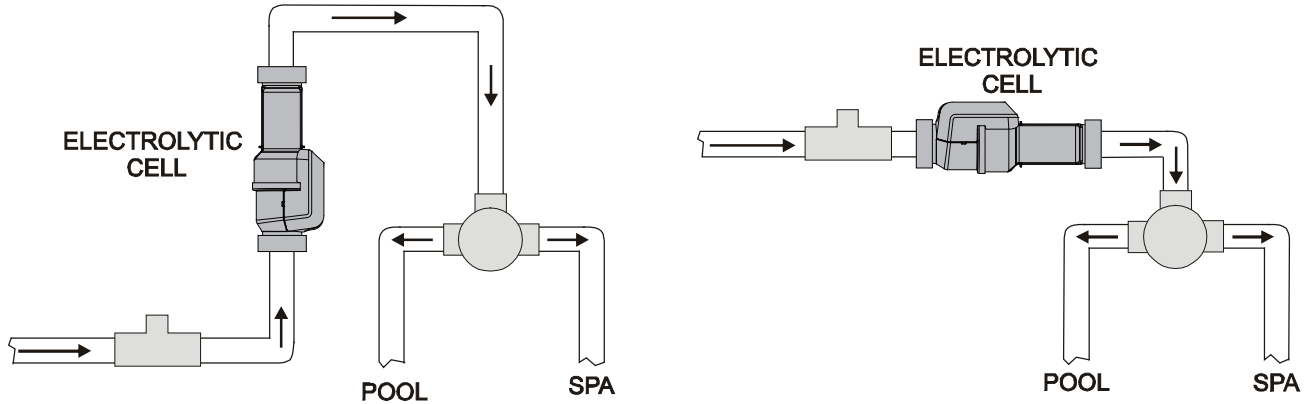

The cell may be mounted vertically or horizontally, and water can move in either direction through the cell. Install using the 2" unions provided. Tighten unions BY HAND for a watertight seal. For systems with 1½" plumbing use adapters (provided by installer).

Flow Switch (supplied with P-KIT)

A Hayward flow switch is required if using the optional TurboCell for chlorination, a liquid chlorine dispenser, chlorine tablet feeder or an AQL-CHEM2 for pH dispensing. The flow switch is a safety device that ensures that water is flowing before the OmniLogic starts to generate/dispense chlorine or dispenses acid. It must be plumbed in the same section of plumbing as the TurboCell or dispenser. Failure to properly install the flow switch can result in explosive gases or harsh chemicals accumulating in the pool plumbing system.

IMPORTANT: There must be at least a 12" (30cm) straight pipe run before (upstream) the flow switch. If the switch is plumbed after the cell, the cell can be counted as the 12" (30cm) of straight pipe.

IMPORTANT: To ensure proper operation, verify that the arrow on the flow switch points in the direction of water flow.

Electrical Wiring

The OmniLogic requires both high and low voltage connections. Low voltage connections will be made to the Control Pad, actuators, sensors, remote keypad, etc. High voltage connections will be made to pumps, lights, etc., as well as providing direct input power to the Control Center. Always:

- Ensure that Power is disconnected prior to performing any wiring
- Follow all local and NEC (CEC if applicable) codes
- Use copper conductors only
- Remove power to the OmniLogic subpanel before removing the deadfront

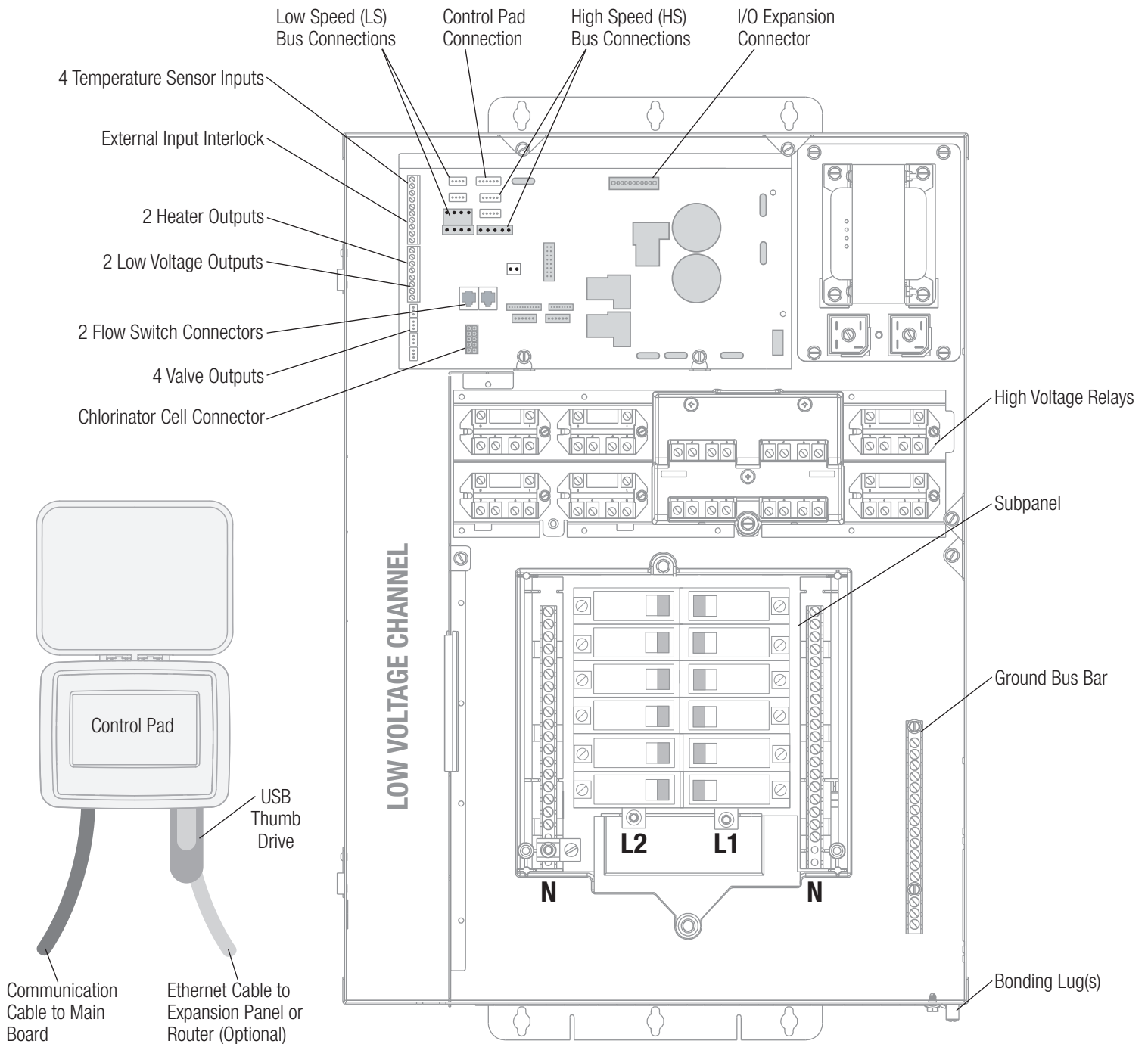



Main Service (Power to the Circuit Breaker Subpanel)

The OmniLogic circuit breaker subpanel can accommodate up to 12 circuit breakers and is rated for 100A service. Run properly rated conductors (L1, L2, N, and ground) from the primary house electrical panel to the main power connections on the OmniLogic circuit breaker base. The connection at the main house panel should be to a 240VAC circuit breaker rated at 100A maximum.

Grounding and Bonding

Connect a ground wire from the primary electrical panel to the OmniLogic ground bus bar. Also ground each piece of high voltage (120 or 240VAC) equipment that is connected to the OmniLogic control relays or circuit breakers. The OmniLogic should also be connected to the pool bonding system by an 8AWG (6AWG for Canada) wire. A lug for bonding is provided on the outside/bottom of the OmniLogic enclosure.

Circuit Breaker Installation and Wiring

Circuit breakers are to be supplied by the installer. Refer to the circuit breaker chart below for a list of suitable circuit breakers that can be used. Follow the code and the circuit breaker manufacturer's rating requirements regarding the size and temperature rating for wiring. Note that some pool equipment may be required to be connected to ground fault circuit breakers—check local and NEC (CEC) codes.

SUITABLE LISTED BREAKERS							Tightening Torque
Manufacturer	Single	Double	Twin	Quad	GFCB	Filler Plates	
Cutler-Hammer	BR	BR	BRD	BRD		BRFP	25lb-in
Murray	MP-T	MP-T	MH-T	MH-T	MP-GT	LX100FP	25lb-in
Siemens	QP	QP	QT	QT	QPF	QF3	25lb-in
Square D	HOM	HOM	HOMT	HOMT	HOM-GFI	HOMFP	25lb-in

General Purpose Outlet

If desired, a duplex receptacle with weatherproof cover (supplied by installer) may be installed in the knockout on the lower right side of the OmniLogic enclosure. Per code, use a GFCI type receptacle or a standard receptacle protected by a Ground Fault Circuit Breaker. When a GFCI receptacle is installed and the control is located outdoors, the GFCI receptacle shall be covered with a UL Listed receptacle cover suitable for outdoor use.

OmniLogic Power

The OmniLogic requires 120VAC, 5A power to operate the control logic circuits and the chlorinator. This power should be connected to a dedicated circuit breaker.

⚠ WARNING: 120VAC only (permanent damage will occur if connected to 240V)

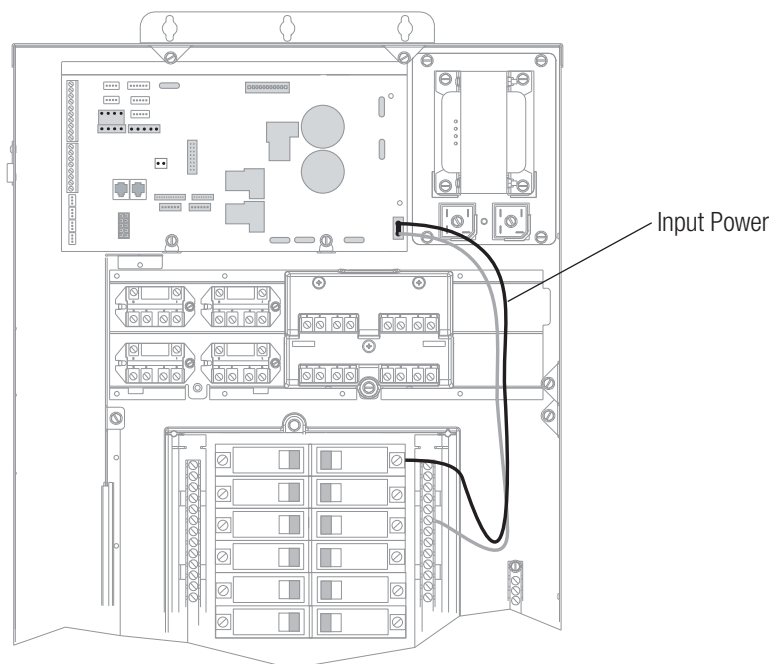

Connection Table

The HLBASE includes 4 high voltage relays, 4 low voltage/heater relays, 4 valve outputs and 4 temperature sensor inputs. Additional relays and inputs/outputs can be added using an HLRELAYBANK, HLIOEXPAND or HLRELAY(s) (see Accessories). When wiring pool equipment to the OmniLogic, keep a record of all connections. You'll need to record which input/output is used and what equipment is attached. To aid in this process, use the table below. To identify the various inputs/outputs, refer to the diagram on the side of the table. After attaching equipment to the OmniLogic, fill in the appropriate information in the table.

Connection Table

Connection	Pool Equipment	Description
High Voltage Relays		
HVR1		
HVR2		
HVR3		
HVR4		
HVR5		
HVR6		
HVR7		
HVR8		
HVR9		
HVR10		

Low Voltage Relays/Heaters		
LVR1		
LVR2		
LVR3		
LVR4		
LVR5		
LVR6		
LVR7		
LVR8		

Valve Actuators		
VLV1		
VLV2		
VLV3		
VLV4		
VLV5		
VLV6		
VLV7		
VLV8		

Temperature Sensors		
SENS1 POOL		
SENS2 AIR		
SENS3 SOLAR		
SENSE4 EXT INP		
SENS5 DE SPA		
SENS6		
SENS7		
SENS8		
SENS9		

- When using Optional HLIOEXPAND
- When using Optional HLRELAYBANK
- When using Optional HLRELAY(s)

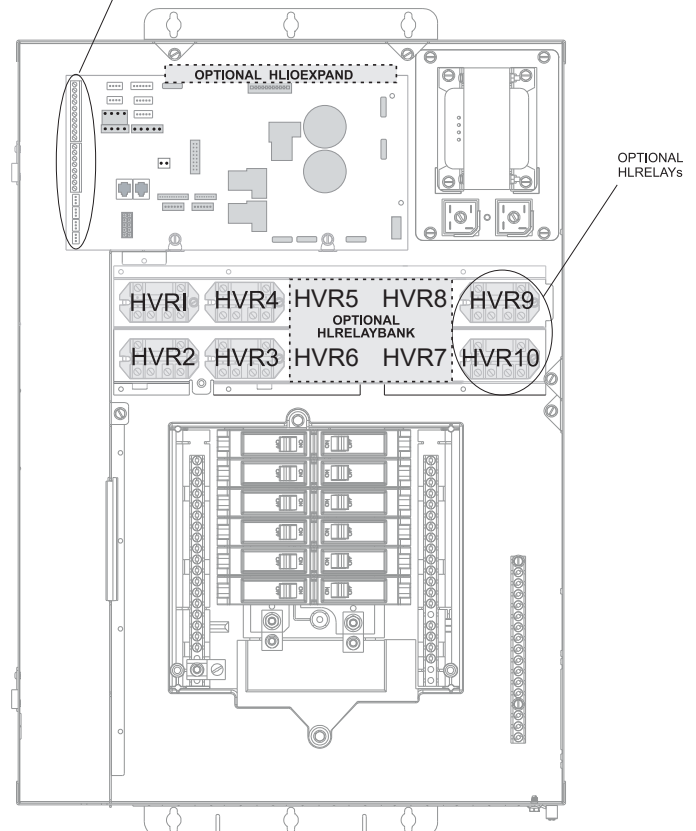
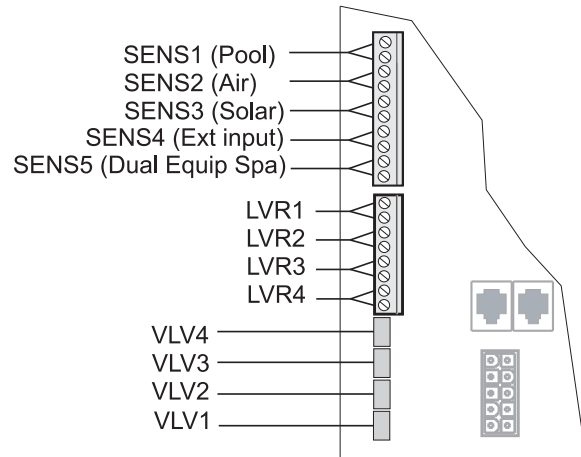

High Voltage Wiring

High Voltage Relays - (120/240V) Pool Equipment

All OmniLogic relays are double pole (they make/break both "legs" of 240V circuits) and are rated at 3HP/20A at 240V (1½HP/20A at 120V) using wire with a minimum insulation rating of 90° C. Refer to the diagram below for typical relay wiring. Record all connections using the table on page 12.

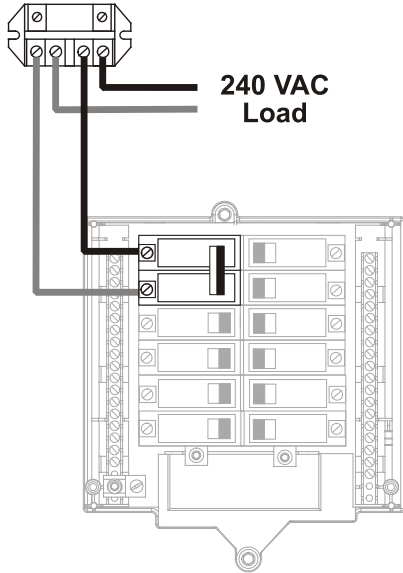

Wiring relays for 240 VAC Pool Equipment

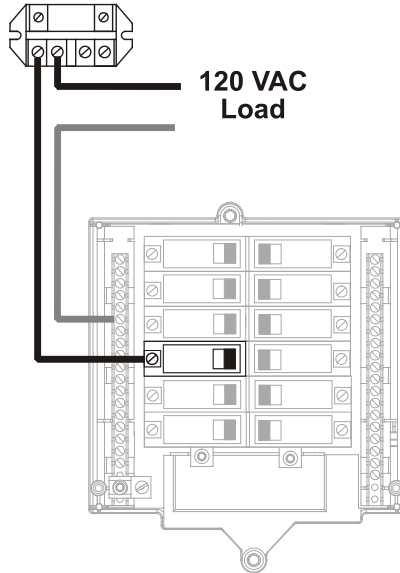

Wiring relays for 120 VAC Pool Equipment

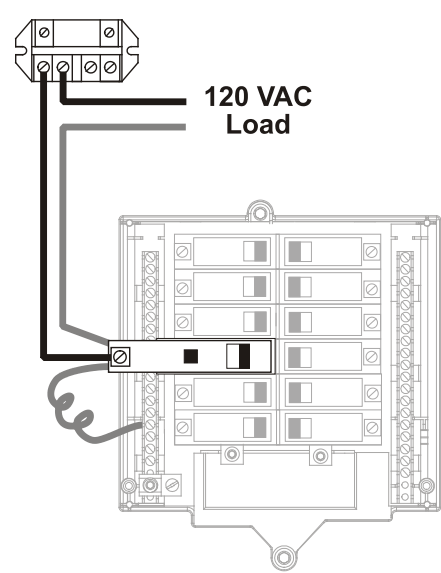

Wiring GFCB for 120 VAC Pool Equipment

⚠ WARNING: Do not use the OmniLogic to control an automatic pool cover. Swimmers may become entrapped underneath the cover.

⚠ WARNING: Do not use the OmniLogic to control fire pits or fire features.

Two speed filter pump

Requires two relays for proper operation of both speeds. NOTE: When selecting relays for two speed operation, note that both relays must be within the Relay Bank (HLRELAYBANK) or neither relay should be within the Relay Bank. The diagram below shows the pump connected to relays *outside* of the Relay Bank.

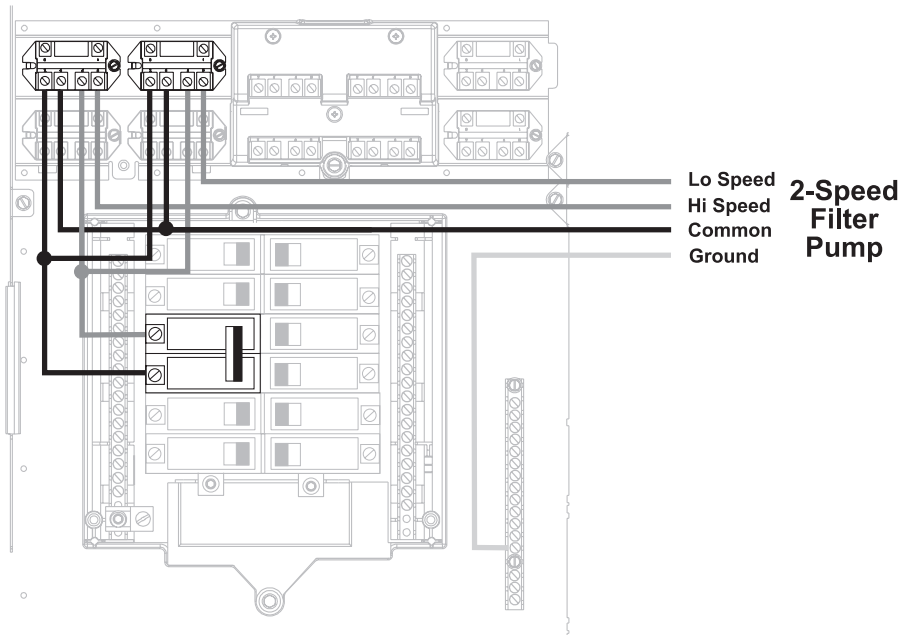



Lights

A ground fault circuit breaker (GFCB) must be used to supply power for high voltage pool/spa lighting. Low voltage lights will require an external transformer. For lighting systems that have both a light source and color wheel, connect the light source to one relay and then connect the color wheel to a different relay.

Universal ColorLogic Lights (UCL): Transformers powering multiple UCLs must be wired to the same relay if synchronization is desired. If UCL(s) will be running in OmniDirect mode (lights built after June 2018), the transformer(s) must be wired to one of the OmniLogic's internal relays, not an HLRELAYBANK relay. Refer to your Universal ColorLogic manual for more information about OmniDirect mode.

Hayward Variable Speed Pump

Proper installation of a Hayward Variable Speed Pump (VSP) includes high voltage input wiring, low voltage communication wiring, and menu configuration/settings. The OmniLogic can control up to 16 VSPs without the use of a relay. Refer to the diagram below for proper 220VAC input wiring to the VSP. Refer to "Low Voltage Wiring" section in this manual for information on communication wiring. Refer to the VSP manual(s) for detailed wiring information.

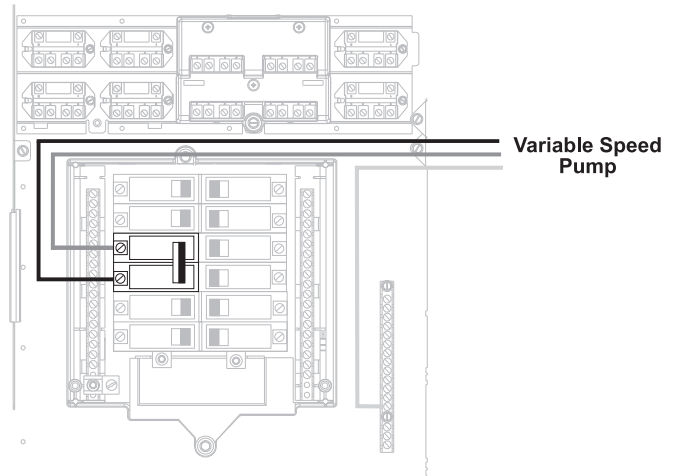

pH Dispense Output

When used with a Hayward HL-CHEM, a pH dispensing device may be used. The HL-CHEM is an ORP and pH sensing kit that is offered as an accessory for OmniLogic pool automation controls. The HL-CHEM continuously tests the pool's sanitization and pH levels allowing the OmniLogic to automatically generate/dispense the correct amount of chlorine and dispense the proper amount of pH reducer. Together, they provide an automated system controlling both sanitization and pH balance. Refer to the HL-CHEM's owner's manual for detailed pH dispense wiring instructions.

Low Voltage Wiring

Control Pad

The Control Pad is weather resistant and comes with a 15 ft cord. Its resistive touch screen with flip down cover is designed to function year round directly in the elements. Because it plugs into the OmniLogic Main Board, it should be mounted close by, but in a location that is convenient for the user to periodically view and change pool/spa settings. Lastly, the Control Pad contains the Wifi radio and its location should be considered if planning to use a wireless connection to the home router or access point. A wireless mobile device (phone, tablet, etc.) could be used to test the signal strength at the intended mounting location. The Control Pad features a USB connector for firmware updates and an Ethernet connector for an optional direct wire connection to your router (if wifi won't be used).

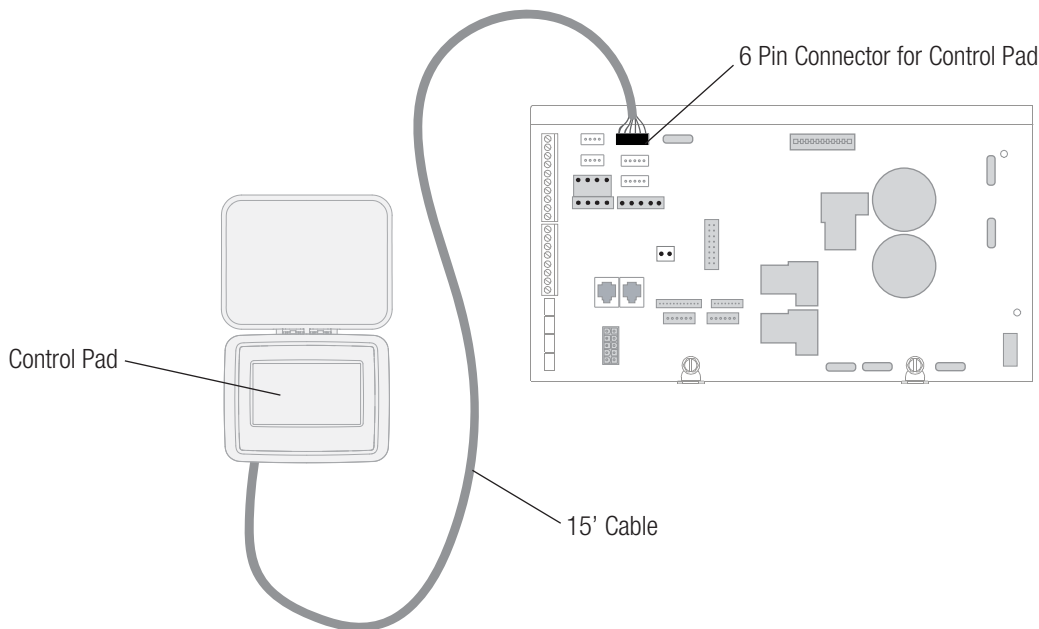



Low Speed Bus Jumper

The large Low Speed Bus connector (see page 10) is used for communication to various equipment like variable speed pumps, Spa Side remote controls, and more. The connector can accommodate multiple connections but if more capacity is needed, a jumper can be made using Wago lever nuts or standard electrical wire nuts as shown. Refer to your equipment's manual for actual wiring instructions.

Hayward Variable Speed Pump (VSP) Wiring

Hayward VSPs connect to the OmniLogic's Low Speed Bus. Refer to your EcoStar or Tristar manual for proper low voltage communication wiring between the OmniLogic and the Hayward Variable Speed Pump.

Valve Actuators

The OmniLogic HLBASE can control up to four automatic valve actuators. When used with the optional Input/Output Expander Board (HLIOEXPAND), up to 8 valve actuators can be used. Two of the valve outputs are normally used for the pool/spa suction (Valve2) and return (Valve1) valves. Valve3 and Valve4 are for general purpose use (solar, water feature, in-floor cleaner, etc.). All valve outputs on the HLIOEXPAND can be used in any manner.

For installations with solar heating, Hayward offers the AQ-SOL-KIT-xx solar kit that contains a valve, actuator, and extra temperature sensor. The "xx" indicates the valve type from the 2 choices below:

- 1P 1.5" Positive Seal
- 2P 2" Positive Seal

The OmniLogic is compatible with standard valve actuators manufactured by Hayward, Pentair/Compool, and Jandy. Actuators will connect to the VLV outputs on the Main Board. Refer to the diagram on page 12 for the location of valve connectors (VLV) on the OmniLogic Main Board. Record all connections in the Connection Table on page 12.

Heater Control

The HLBASE OmniLogic provides a set of 4 low voltage dry contacts that can be connected to most heaters with 24V control circuits. When used with the optional Input/Output Expander Board (HLIOEXPAND), 8 dry contact relays are available. Refer to the following diagrams for wiring connections to generic and Hayward conventional heaters. For Hayward Smart Heaters, refer to the wiring information on page 17. The manuals supplied with most heaters also include specific wiring instructions for connecting the heater to an external control (usually identified as "2-wire" remote control). For millivolt or line voltage heaters, contact Hayward Tech support, 908-355-7995. Refer to the diagram on page 12 for the location of heater connections (LVR) on the OmniLogic Main Board. Record all connections in the Connection Table.

Generic Heaters

1. Wire heater to 120/240V power source per the instructions in the heater manual. The OmniLogic does NOT control the power going to the heater.
2. Wire the OmniLogic dry contact heater output per the diagram below. Many internal parts of the heater can get very hot--see the heater manufacturer's recommendations on the minimum temperature rating for wires. If no guidance is given, use 105°C rated wire.
3. Set any ON/OFF switch on the heater to ON.
4. Set the thermostat(s) on the heater to the maximum (hottest) setting.

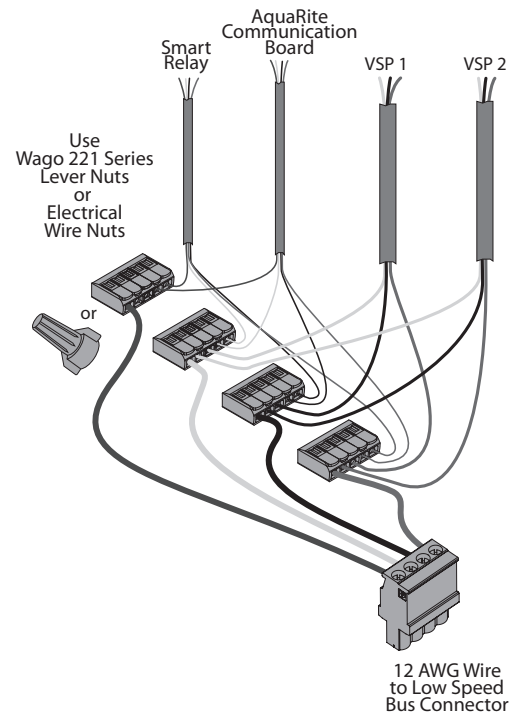
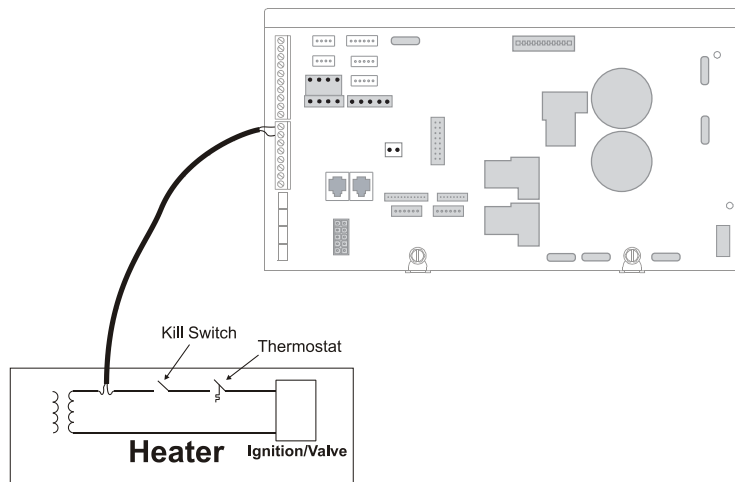



Hayward Pre-2007 Heaters

Refer to the instructions in the heater manual for “2-wire Remote Thermostat” operation under “Remote Control Connections” and the diagram below:

1. Turn off power to heater.
2. Wire OmniLogic to terminals 1 & 2 (see diagram).
3. Leave jumper attached to terminals 4 & 5.
4. Move “BYPASS” dipswitch on heater circuit board to “ON” position (up).
5. Turn heater power back on.
6. Switch heater to either “Pool” or “Spa” (it doesn’t make any difference which is selected, the OmniLogic will take control).
7. Heater display should be “b0” (for “bypass On”).
8. Heater will start whenever OmniLogic requests.

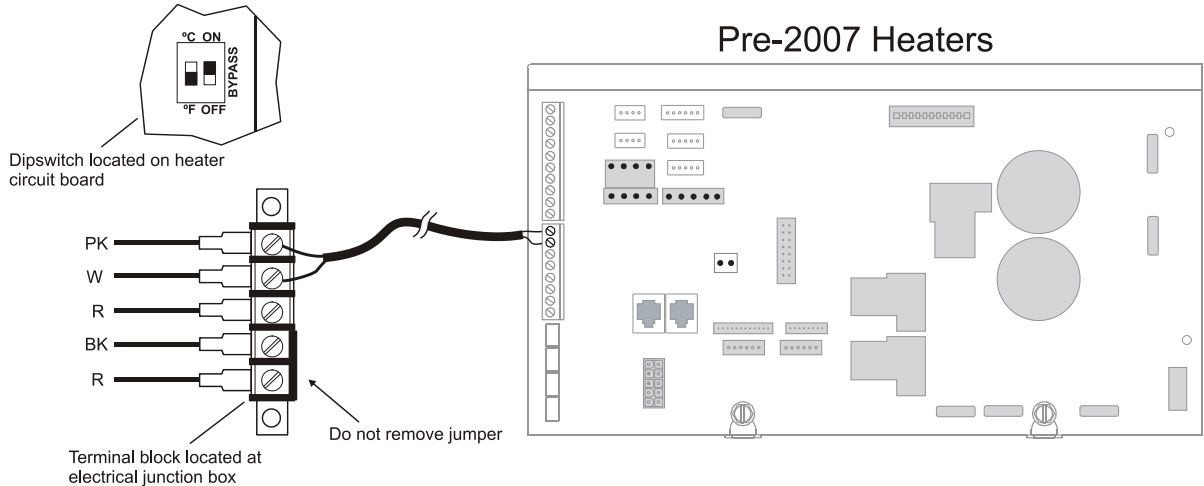

Hayward 2007-Current Heaters

Refer to the instructions in the heater manual for “2-wire Remote Thermostat” operation under “Remote Control Connections” and the diagram below:

1. Turn off power to heater.
2. Wire OmniLogic to the heater terminals that have the Orange & White connections (see diagram).
3. Turn heater power back on.
4. Use the “MODE” key on the heater keypad to put the control into “STANDBY” mode.
5. Press and hold both the “DOWN” and “MODE” keys for 3 seconds until the display shows the code “bo”.
6. Be sure to put the heater’s control in either “POOL” or “SPA” mode.
7. The OmniLogic will now control the heater.

To configure the heater for 2-wire remote thermostat control, use the “MODE” key on the heater keypad to put the control into “STANDBY” mode. Then press and hold both the “DOWN” and “MODE” keys for 3 seconds until the display shows the code “bo”.

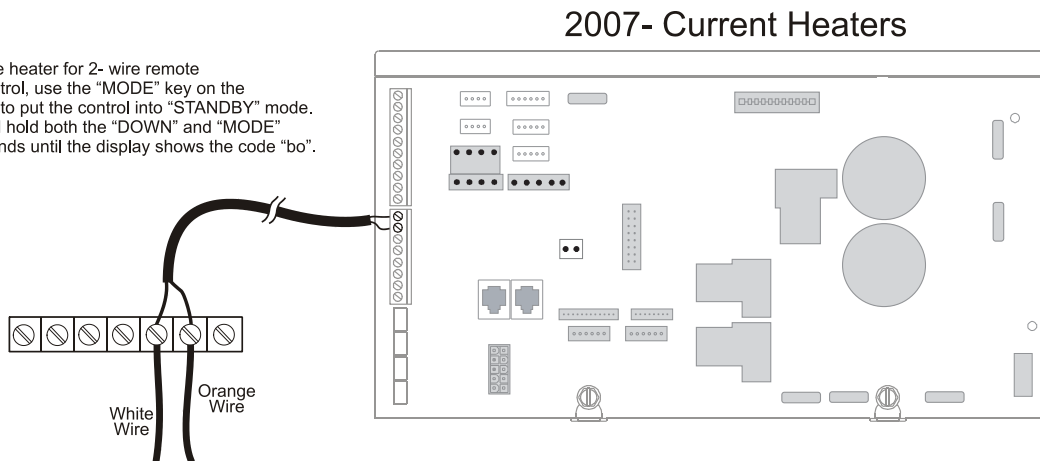



Smart Heaters

Smart Heaters are programmed with a Hayward Unique Address (HUA) which allows it to be fully controlled by a Hayward Omni pool automation control. Similar to other Smart Devices such as select Hayward variable speed pumps, you will be able to remotely create schedules and setpoints for both heating and cooling while displaying real time heater status and diagnostics for the Smart Heater. The Omni family of products provide a 3 wire cable connection used to communicate with the Smart Heater and requires firmware revision R4.3.0 or later.

Disconnect power to both the Smart Heater and the Omni control before removing their panels. Use a proper outdoor rated 3 conductor 22 AWG cable (20 AWG for runs over 30 ft) for the connection from the Omni control to the Smart Heater. Route the cable through appropriate knockouts making sure they are not shared with high voltage wiring. Refer to the diagram below showing a Hayward OmniLogic control wired to the Smart Heater. Note that the position of each colored conductor is the same at both ends of the communication cable. Refer to your Smart Heater manual for specific wiring instructions. After the communication cable is fastened and secure, refasten the panels.

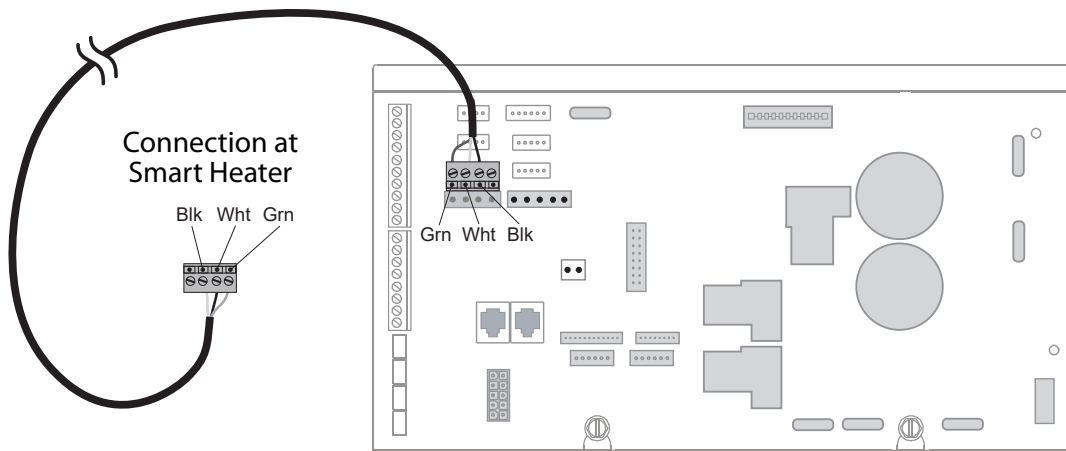

Temperature Sensors

The OmniLogic utilizes 10K ohm thermistor type sensors and provides three inputs. Three sensors (water temperature, air temperature and solar or dual equipment spa temperature) are included. If the OmniLogic is being used to control a solar heating system, the solar sensor is required. If dual equipment will be used, the dual equipment spa sensor is required. If both solar and dual equipment are desired, another temperature sensor must be purchased separately. The sensors are provided with a 15 ft. cable. If a longer cable is required, contact the Hayward service dept. (908-355-7995) for information on suitable cable types and splices. Wire sensors as shown below. Record all connections using the table on page 12.

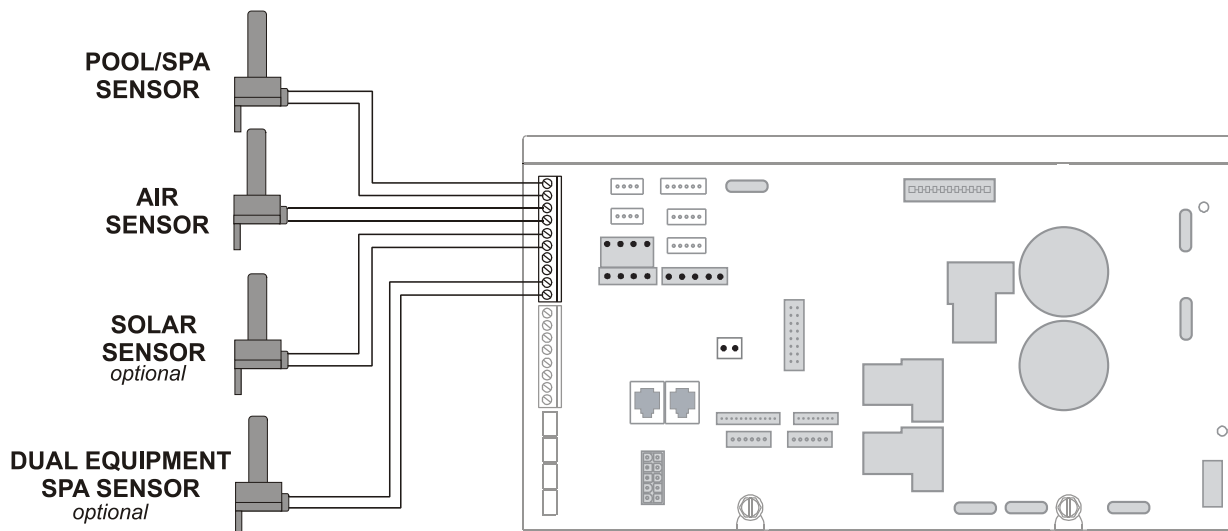

External Input Interlock

The External Input Interlock provides a means to turn the filter pump or other component on/off when certain conditions exist. A normally open or normally closed external device must be connected to the OmniLogic as shown below. After properly configuring the OmniLogic (see Configuration Wizard), the filter pump and/or desired pool component will be forced on or off when the device is active. Record all connections using the table on page 12.

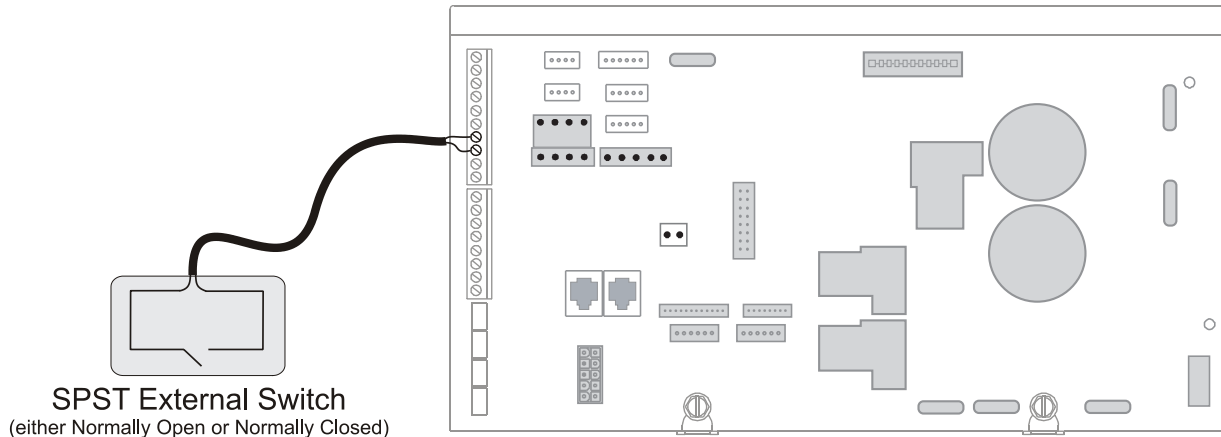

Remote Terminal

Up to 2 wired HLWALLMOUNT touchscreen remote terminals can be wired to the OmniLogic. Use 24 AWG (or better) four conductor cable (typically phone cable) to connect the wired remote terminal to the OmniLogic's High Speed Bus as shown below. Note that the screw connections on both the OmniLogic main unit and the wired remote terminal are numbered: Connect 1 to 1, 2 to 2, etc. as shown in the diagram below. Although the High Speed Bus has 5 screw terminals, screw #5 is not used. Refer to the HLWALLMOUNT manual for maximum distances and complete installation instructions.

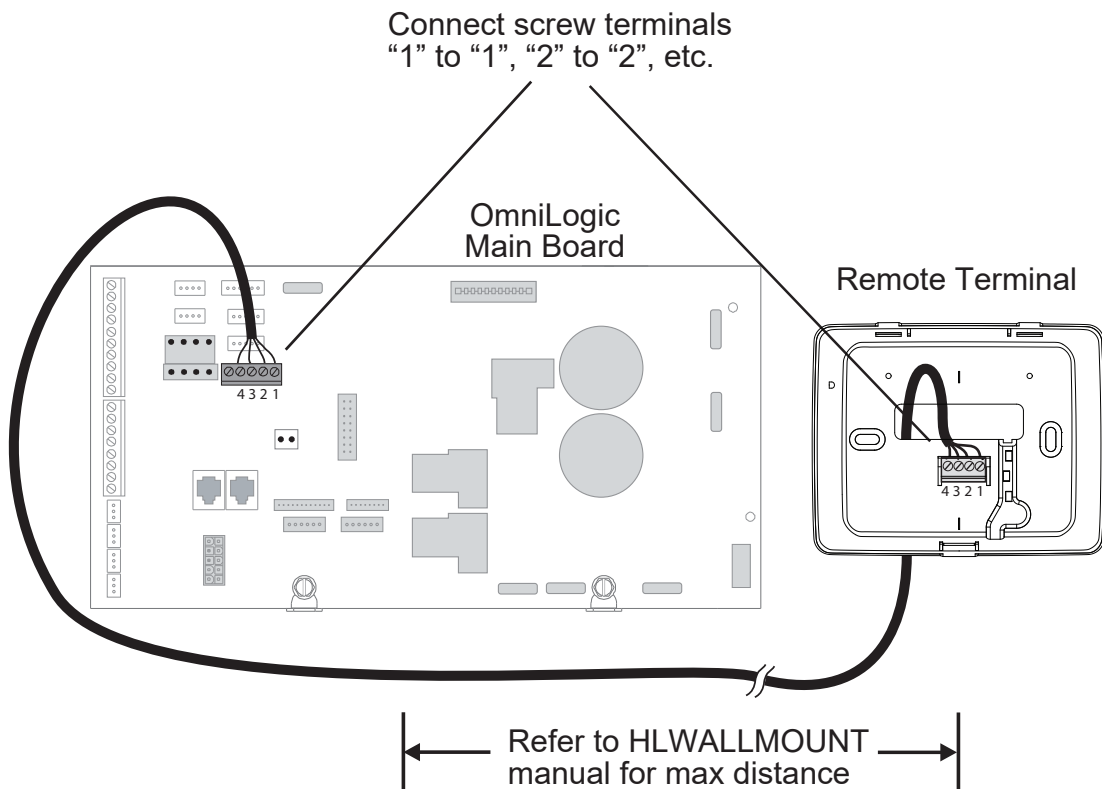



HL-CHEM ORP and pH Sensing Kit

Plug in the connector from the HL-CHEM into one of the Low Speed Bus connectors on the main PCB in the OmniLogic Control Center as shown below. Refer to the HL-CHEM manual for complete installation instructions.

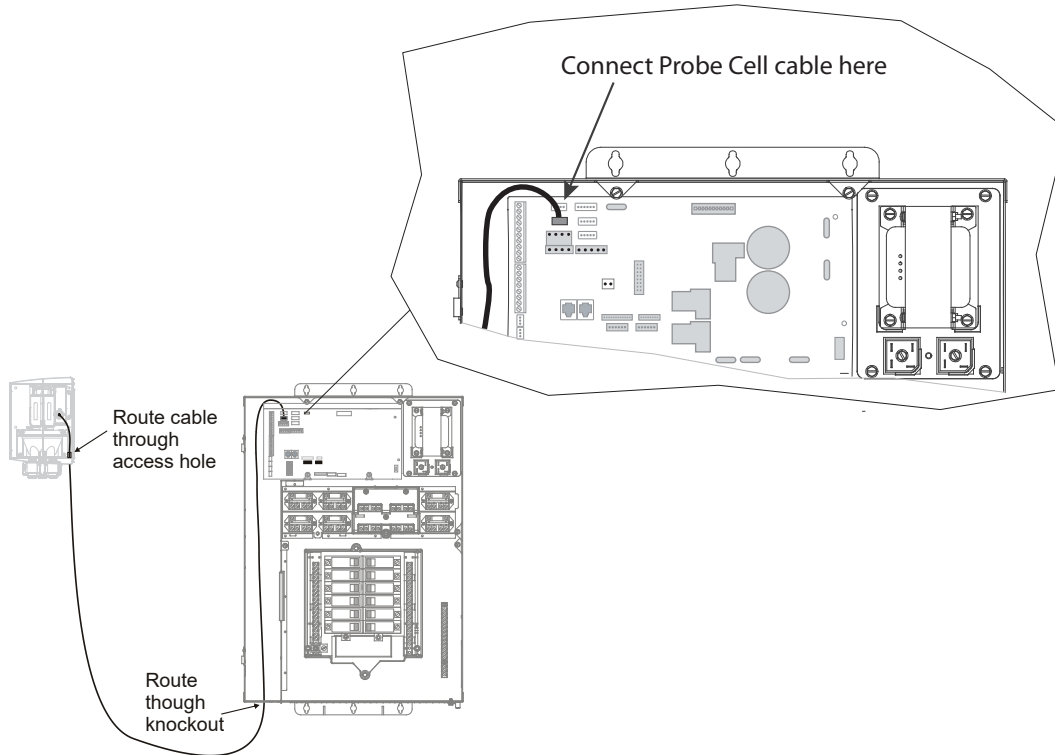

Home Router

Connection to the web is optional. If web enabled devices such as a PC, laptop, tablet or phone will be used to access the OmniLogic, either a wireless or wired connection can be made to the home router. If wireless is desired, the OmniLogic requires a 2.4GHz connection to the router. If using a wired ethernet connection, use outdoor rated Cat5e or Cat6 ethernet cable and connect one end to the Control Pad and the other to an available LAN port (not WAN) on the home router as shown below.

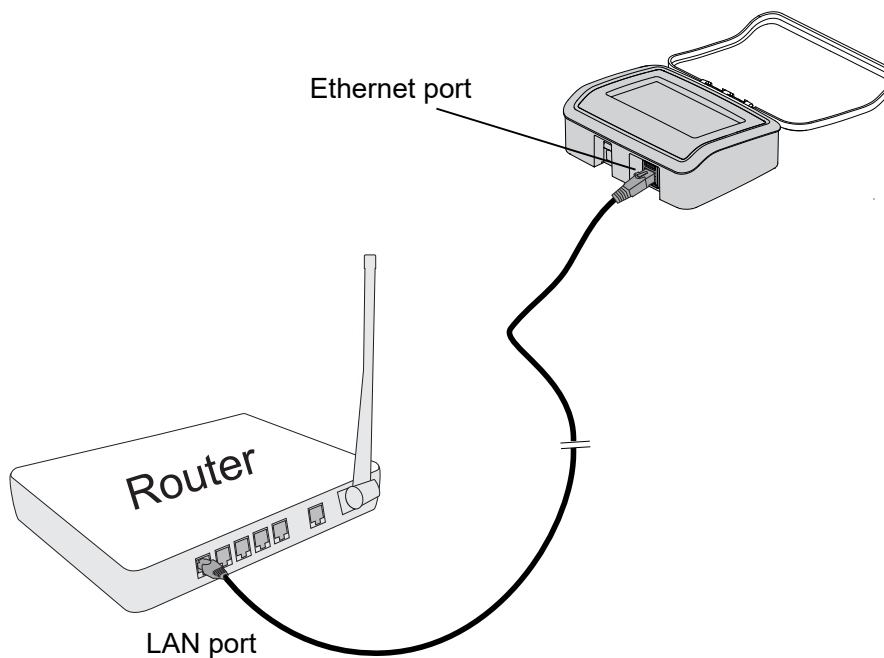



HAYWARD®

Flow Switch

Only applicable if the chlorinator function is enabled and/or if an optional HL-CHEM will be used. The flow switch cable plugs into the flow switch connector on the OmniLogic's Main Board as shown on page 10. Ensure that the connector catch "snaps" in order to provide a reliable connection.

TurboCell

Only applicable if the chlorinator function is enabled. The TurboCell should be plugged in AFTER the OmniLogic cover panel is installed. Refer to page 10 for the location of the chlorinator cell connector.

HLIOEXPAND

The HLIOEXPAND is design to slide between guide rails and insert into a dedicated slot on the OmniLogic main board. At startup, the OmniLogic will discover the HLIOEXPAND and its inputs/outputs can be configured within the OmniLogic's CONFIGURATION WIZARD. Refer to the HLIOEXPAND manual for installation instructions.

HLRELAYBANK

Offering four additional high voltage relays, the HLRELAYBANK is a relay kit accessory designed to install next to the four on-board relays in the HLBASE. After installing the HLRELAYBANK, a wire connection must be made at the OmniLogic Main Board. At startup, the OmniLogic will detect the HLRELAYBANK and allow the user to configure the additional relays in the CONFIGURATION WIZARD. Refer to the HLRELAYBANK manual for installation instructions.

HLRELAY

The HLRELAY is a single high voltage relay designed to be mounted in the #9 and/or #10 positions near the four on-board relays. After installing the HLRELAY, a wire connection must be made at the OmniLogic Main Board. At startup, the OmniLogic will detect the HLRELAY and allow the user to configure the additional relay(s) in the CONFIGURATION WIZARD. Refer to the HLRELAY manual for installation instructions.

Preparing Pool/Spa Water

Salt Chlorination

When used with an optional Hayward TurboCell and P-KIT, the OmniLogic can generate all the chlorine needs for pools up to 40,000 gallons (150,000 liters), or the needs of most commercial pools up to 25,000 gallons (95,000 liters). If enabled (see Configuration Wizard), this operation requires a low concentration of salt (sodium chloride) in the pool/spa water. The OmniLogic automatically converts salt into free chlorine which kills bacteria and algae in the pool/spa. Chlorine will revert back to sodium chloride after killing bacteria. These reactions will continuously recycle, virtually eliminating the need to add sanitizing chemicals to your pool/spa. The only time you may need to add more salt to the pool/spa is when water is replenished due to backwashing, draining, or splashing (not evaporation). The actual amount of chlorination required to properly sanitize a pool varies due to bather load, rainfall, temperature, and the pool's cleanliness.

General Water Chemistry

Salt is required only if you are using the chlorinator features on the OmniLogic Control Center. If you are NOT using the chlorinator, it is recommended that you follow all of the other chemistry recommendations besides salt.

Water Chemistry

This table summarizes the levels that are recommended by the Association of Pool and Spa Professionals (APSP). The only special requirements for the OmniLogic are the salt level and stabilizer.

CHEMICAL	IDEAL LEVELS
Salt	2700 to 3400 ppm
Free Chlorine	1.0 to 3.0 ppm
pH	7.2 to 7.8
Cyanuric Acid (Stabilizer)	30 to 50 ppm
Total Alkalinity	80 to 120 ppm
Calcium Hardness	200 to 400 ppm
Metals	0 ppm
Saturation Index	-.2 to .2 (0 best)



Saturation index

The saturation index (Si) relates to the calcium and alkalinity in the water and is an indicator of the pool water "balance". Your water is properly balanced if the Si is 0 ± 0.2 . If the Si is below -0.2 , the water is corrosive and plaster pool walls will be dissolved into the water. If the Si is above $+0.2$, scaling and staining will occur. Use the chart below to determine the saturation index.

$$Si = pH + Ti + Ci + Ai - TDS$$

°C	°F	Ti	Hardness Calcium	Ci	Total alkalinity	Ai	Total Dissolved Solids	TDS
12	53	0.3	75	1.5	75	1.9	0-1000	12.10
16	60	0.4	100	1.6	100	2.0	1001-2000	12.29
19	66	0.5	125	1.7	125	2.1	2001-3000	12.35
24	76	0.6	150	1.8	150	2.2	3001-4000	12.41
29	84	0.7	200	1.9	200	2.3	4001-5000	12.44
34	94	0.8	250	2.0	250	2.4		
39	102	0.9	300	2.1	300	2.5		
			400	2.2	400	2.6		
			600	2.4	600	2.8		
			800	2.5	800	2.9		

Use: Measure the pH of the pool water, the temperature, water hardness, total alkalinity, and total dissolved solids. Use the table above to determine Ti, Ci, Ai, and TDS in the formula shown above. If the Si is equal to 0.2 or more, stains may appear. If the Si is equal to -0.2 or less, corrosion or deterioration may occur.

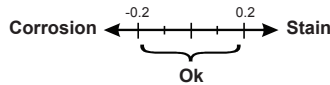

The pool's chemistry must be balanced BEFORE activating the OmniLogic's optional chlorinator function. NOTE: If the pool does not have new water, add metal remover and non-copper based algaecide to the pool, per manufacturer's instructions. This ensures a quick, troublefree transfer to the OmniLogic system.

Salt (When using optional chlorinator function)

Use the chart on the following page to determine how much salt in pounds or (Kgs) should be added to reach the recommended levels. Use the Pool Sizing Formula below (measurements are in feet/gallons and meters/liters) if pool size is unknown.

	Gallons (pool size in feet)	Liters (pool size in meters)
Rectangular	Length x Width x Average Depth x 7.5	Length x Width x Average Depth x 1000
Round	Diameter x Diameter x Average Depth x 5.9	Diameter x Diameter x Average Depth x 785
Oval	Length x Width x Average Depth x 6.7	Length x Width x Average Depth x 893

The OmniLogic can run in Standard mode or Low Salt mode (see page 29). When in Standard mode, the pool's recommended salt level is between 2700-3400 PPM (parts per million). For Low Salt mode, the salt level should be between 1200 - 1800 PPM with 1500 PPM optimal. Before adding any salt, test the salt level. This is especially important for retrofit installation to older pools where all of the chlorine added to the pool over time is ending up as salt. If the level is low, determine the number of gallons in the pool and add salt according to the chart below. A high salt level can cause the OmniLogic to stop chlorinating. The salt in your pool/spa is constantly recycled and the loss of salt throughout the swimming season should be minimal. This loss is due primarily to the addition of water because of splashing, backwashing, or draining (because of rain). Salt is not lost due to evaporation.



POUNDS and (Kg) OF SALT NEEDED FOR 3200 PPM

Current salt level ppm	Gallons and (Liters) of Pool/Spa water																
	8,000 (30,000)	10,000 (37,500)	12,000 (45,000)	14,000 (52,500)	16,000 (60,000)	18,000 (67,500)	20,000 (75,000)	22,000 (82,500)	24,000 (90,000)	26,000 (97,500)	28,000 (105,000)	30,000 (112,500)	32,000 (120,000)	34,000 (127,500)	36,000 (135,000)	38,000 (142,500)	40,000 (150,000)
0	213 (97)	267 (121)	320 (145)	373 (170)	427 (194)	480 (218)	533 (242)	587 (267)	640 (291)	693 (315)	747 (339)	800 (364)	854 (388)	907 (412)	960 (436)	1013 (460)	1067 (484)
200	200 (91)	250 (114)	300 (136)	350 (159)	400 (182)	450 (205)	500 (227)	550 (250)	600 (273)	650 (295)	700 (318)	750 (341)	800 (363)	850 (385)	900 (408)	950 (430)	1000 (453)
400	187 (85)	233 (106)	280 (127)	327 (148)	373 (170)	420 (191)	467 (212)	513 (233)	560 (255)	607 (276)	653 (297)	700 (318)	747 (339)	793 (360)	840 (382)	887 (403)	933 (424)
600	173 (79)	217 (98)	260 (118)	303 (138)	347 (158)	390 (177)	433 (197)	477 (217)	520 (236)	563 (256)	607 (276)	650 (297)	693 (317)	737 (337)	780 (358)	823 (378)	867 (398)
800	160 (73)	200 (91)	240 (109)	280 (127)	320 (145)	360 (164)	400 (182)	440 (200)	480 (218)	520 (236)	560 (255)	600 (273)	640 (291)	680 (310)	720 (328)	760 (346)	800 (364)
1000	147 (67)	183 (83)	220 (100)	257 (117)	293 (133)	330 (150)	367 (167)	403 (183)	440 (200)	477 (217)	513 (233)	550 (250)	587 (267)	623 (283)	660 (300)	697 (317)	733 (333)
1200	133 (61)	167 (76)	200 (91)	233 (106)	267 (121)	300 (136)	333 (152)	367 (167)	400 (182)	433 (197)	467 (212)	500 (227)	533 (243)	567 (258)	600 (274)	633 (289)	667 (304)
1400	120 (55)	150 (68)	180 (82)	210 (95)	240 (109)	270 (123)	300 (136)	330 (150)	360 (164)	390 (177)	420 (191)	450 (205)	480 (218)	510 (232)	540 (246)	570 (259)	600 (263)
1600	107 (48)	133 (61)	160 (73)	187 (85)	213 (97)	240 (109)	267 (121)	293 (133)	320 (145)	347 (158)	373 (170)	400 (182)	427 (195)	453 (207)	480 (219)	507 (231)	533 (243)
1800	93 (42)	117 (53)	140 (64)	163 (74)	187 (85)	210 (95)	233 (106)	257 (117)	280 (127)	303 (138)	327 (148)	350 (159)	373 (169)	397 (180)	420 (190)	443 (201)	467 (211)
2000	80 (36)	100 (45)	120 (55)	140 (64)	160 (73)	180 (82)	200 (91)	220 (100)	240 (109)	260 (118)	280 (127)	300 (136)	320 (145)	340 (154)	360 (163)	380 (172)	400 (181)
2200	67 (30)	83 (38)	100 (45)	117 (53)	133 (61)	150 (68)	167 (83)	183 (91)	200 (98)	217 (106)	233 (114)	250 (114)	267 (121)	283 (129)	300 (137)	317 (144)	333 (152)
2400	53 (24)	67 (30)	80 (36)	93 (42)	107 (48)	120 (55)	133 (61)	147 (67)	160 (73)	173 (79)	187 (85)	200 (91)	213 (98)	227 (104)	240 (110)	253 (117)	267 (123)
2600	40 (18)	50 (23)	60 (27)	70 (32)	80 (36)	90 (41)	100 (45)	110 (50)	120 (55)	130 (59)	140 (64)	150 (68)	160 (73)	170 (77)	180 (81)	190 (86)	200 (90)
2800	27 (12)	33 (15)	40 (18)	47 (21)	53 (24)	60 (27)	67 (30)	73 (33)	80 (36)	87 (39)	93 (42)	100 (45)	107 (48)	113 (51)	120 (54)	127 (57)	133 (60)
3000	13 (6)	17 (8)	20 (9)	23 (11)	27 (12)	30 (14)	33 (15)	37 (17)	40 (18)	43 (20)	47 (21)	50 (23)	53 (24)	57 (26)	60 (27)	63 (29)	67 (30)
3200	Ideal	Ideal	Ideal	Ideal	Ideal	Ideal	Ideal	Ideal	Ideal	Ideal	Ideal	Ideal	Ideal	Ideal	Ideal	Ideal	Ideal
3400	OK	OK	OK	OK	OK	OK	OK	OK	OK	OK	OK	OK	OK	OK	OK	OK	OK
3600+	Dilute	Dilute	Dilute	Dilute	Dilute	Dilute	Dilute	Dilute	Dilute	Dilute	Dilute	Dilute	Dilute	Dilute	Dilute	Dilute	Dilute

Type of Salt to Use

It is important to use only sodium chloride (NaCl) salt that is greater than 99.0% pure. This can be found at most pool stores in 40-80 lb. bags labeled "for use in swimming pools". Alternatively, use common food quality or water softener salt that is at least 99.0% pure. It is also acceptable to use water conditioning salt pellets, however, it will take longer for them to dissolve. Do not use rock salt, or salt with more than 1% of yellow prussiate of soda, salt with anti-caking additives, or iodized salt.

How to Add Salt

For new plaster pools, wait 10-14 days before adding salt to allow the plaster to cure. Turn the circulating pump on and add salt directly into the pool. Brush the salt around to speed up the dissolving process – do not allow salt to pile up on the bottom of the pool. Run the filter pump for 24 hours with the suction coming from the main drain (use pool vacuum if there is no main drain) to allow the salt to evenly disperse throughout the pool. The salt display may take 24 hours to respond to the change in salt concentration.

Always check stabilizer (cyanuric acid), when checking salt. These levels will most likely decline together. Use the chart below to determine how much stabilizer must be added to raise the level to 40 ppm.

POUNDS and (Kg) OF STABILIZER (CYANURIC ACID) NEEDED FOR 40 PPM

Current Stabilizer level (ppm)	Gallons and (Liters) of Pool Water																
	8,000 (30000)	10,000 (37500)	12,000 (45000)	14,000 (52500)	16,000 (60000)	18,000 (67500)	20,000 (75000)	22,000 (82500)	24,000 (90000)	26,000 (97500)	28,000 (105000)	30,000 (112500)	32,000 (120000)	34,000 (127500)	36,000 (135000)	38,000 (142500)	40,000 (150000)
0 ppm	2.7 (1.2)	3.4 (1.5)	4.0 (1.8)	4.7 (2.2)	5.4 (2.5)	6.0 (2.7)	6.7 (3.0)	7.4 (3.4)	8.0 (3.6)	8.7 (4.0)	9.4 (4.3)	10.0 (4.5)	10.8 (5.0)	11.4 (5.2)	12 (5.4)	12.7 (5.7)	13.4 (6)
10 ppm	2.0 (.9)	2.5 (1.1)	3.0 (1.4)	3.5 (1.6)	4.0 (1.8)	4.5 (2.0)	5.0 (2.3)	5.5 (2.5)	6.0 (2.7)	6.5 (3.0)	7.0 (3.2)	7.5 (3.4)	8 (3.6)	8.5 (3.8)	9 (4.0)	9.5 (4.3)	10 (4.6)
20 ppm	1.3 (.59)	1.7 (.77)	2.0 (.90)	2.3 (1.1)	2.7 (1.3)	3.0 (1.3)	3.3 (1.5)	3.7 (1.6)	4.0 (1.8)	4.3 (2.0)	4.6 (2.1)	4.9 (2.2)	5.4 (2.4)	5.7 (2.5)	6 (2.6)	6.3 (2.8)	6.6 (3.0)
30 ppm	0.7 (.31)	0.8 (.36)	1.0 (.45)	1.2 (.54)	1.4 (.64)	1.5 (.68)	1.7 (.77)	1.8 (.82)	2.0 (.91)	2.2 (.97)	2.4 (1.1)	2.6 (1.2)	2.8 (1.3)	2.9 (1.3)	3.0 (1.4)	3.2 (1.4)	3.4 (1.5)
40 ppm	0.0	0.0	0.0	0.0	0.0	0.0	0.0	0.0	0.0	0.0	0.0	0.0	0.0	0.0	0.0	0.0	0.0



System Startup

Before Startup

Before starting the OmniLogic for the first time, be sure that the following items have been completed:

1. Pool/spa chemicals are within the recommended levels according to the chart on page 20.
2. If using chlorinator function, pool/spa salt level is between 2700 – 3400 PPM Standard Salt or 1200-1800 PPM Low Salt (see page 29).
3. Properly rated circuit breakers are installed in the OmniLogic subpanel.
4. All wiring is performed according to NEC and local codes.
5. The OmniLogic is properly grounded and bonded.

Firmware Upgrade

The OmniLogic's firmware is the basic operating system that runs the unit. The OmniLogic was shipped with the version of firmware that was available at the time of release. There may be a newer version available and if so, we encourage you to upgrade. Also, if you have experienced problems, Hayward Technical Support may advise you to upgrade your OmniLogic firmware. To upgrade the OmniLogic firmware, refer to the procedure shown in the OmniLogic Operation Manual. Upgrading firmware can be performed before or after Configuration but should be done before the OmniLogic begins operation.

Configuration

Initial Configuration

When all input and pool related wiring is complete, replace and secure the deadfront. The OmniLogic can now be powered on for the first time. Apply power at the main panel and wait for the OmniLogic to completely start. This may take a full minute or two. Because this is the first time that the OmniLogic has been powered on, it will bring you directly to the initial configuration screen shown below. Note that the Control Pad uses a resistive touchscreen that is appropriate for a pool environment. It requires a deliberate push when selecting a button. At the initial configuration screen, touch the Configuration button in the center of the screen. On the following screen, touch the Configuration Wizard button as shown below.

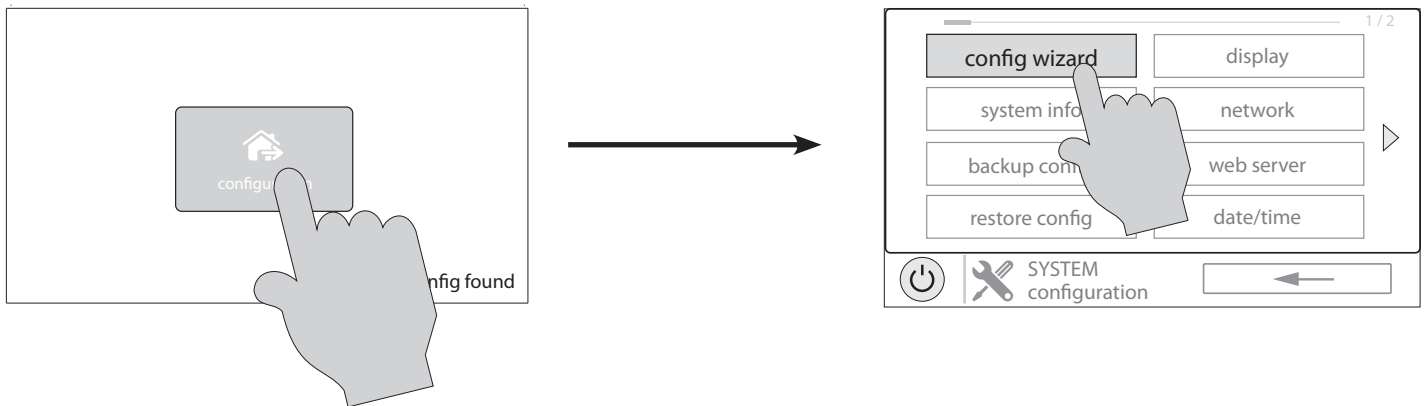

About the Configuration Wizard

The OmniLogic uses a Configuration Wizard to assist in the configuration of the OmniLogic. The Configuration Wizard will ask you general questions relating to your pool/spa and specific questions about connected pool equipment. Because this process may take some time, do not begin to configure the OmniLogic unless you can dedicate at least 15 minutes or more. Configuring the OmniLogic requires knowledge of all of the connected pool equipment so have the Connection Table (page 12) handy while configuring the OmniLogic.

If you are asked a question and don't know the answer, in many cases you'll be able to skip the question and proceed. In some cases the Configuration Wizard will require an answer. Answer the question to the best of your ability and take note as you'll be able to go back into the Configuration Wizard at a later time to make changes.



Navigation

The Configuration Wizard has been designed to be intuitive allowing most users the ability to navigate with little instruction. Below, a list of commonly used buttons are explained.

- Done** - Touch this button to complete your selection.
- Cancel** - Touch this button to cancel your selection.
- Advance** - Touch this button to advance to the next screen.
- Back** - Touch this button to return to the previous screen.
- Add** - Touch this button to add an item
- Delete** - Touch this button to delete a highlighted item.

After being prompted to make a selection or answer a question, touch the Done button (if available) and then the Advance button to go to the next screen. To go back to a previous screen, touch the Back button. Many selections will require you to touch the Done button before allowing you to advance. If a wrong selection has been made, touch the Delete button or Cancel. Some settings can be made by sliding a bar left or right to decrease or increase a value. You may be required to assign names to equipment. In this case, a keyboard will be displayed and you'll be able to type the desired name. After naming the equipment, save then advance. This method is repeated throughout the Configuration Wizard.

Begin the Configuration Wizard

In the Configuration Wizard, select "New" to create a new Configuration file for the OmniLogic. Once underway, keep advancing until you have completed the Wizard. At the end of the Wizard, you'll have the opportunity to save your settings or exit without saving.

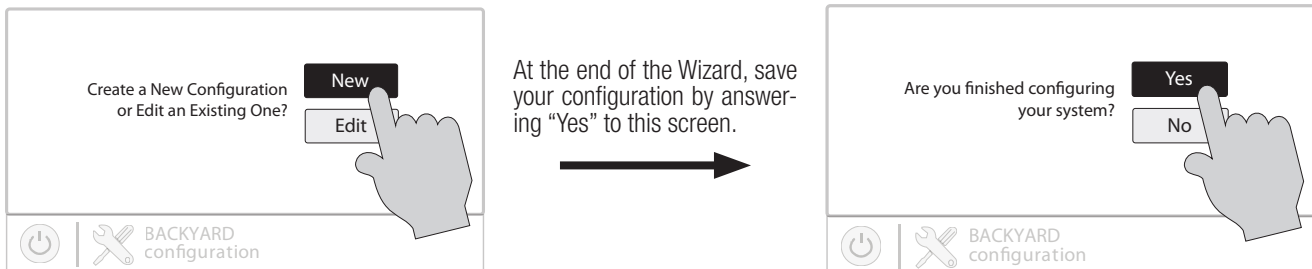

If additional pool or backyard equipment is added after initial configuration, or you'd like to make a change to an existing configuration setting, re-enter the Configuration Wizard and select "Edit". The initial configuration settings will be retained and you'll have an opportunity to make changes or additions. Be sure to save your configuration when exiting. See page 36 for a Quick Edit Guide.

Configuration Wizard Guide

As you progress through the Configuration Wizard, refer to the following information to help answer questions and make selections.

Would You Like To Set Up A Network Connection Now? - You can select whether to connect to the internet through a wired connection (requires ethernet connection shown on page 19) or wireless (requires a 2.4GHz connection to the router). If no connection is desired or you will be setting up the connection later, select "not now".

Enable Screen Color Changes For System Alerts? - To alert the user of warning conditions (no flow, failed sensor, etc.), the OmniLogic can change its screen color. The screen can display yellow or red depending on the severity of the condition.

Time and Date - "Automatically get time and date from internet" and "Automatically adjust for daylight savings time" are enabled by default. It is recommended that you leave them enabled if your OmniLogic system has an internet connection. Disabling "Automatically get time and date from internet" will allow you to set the current date and time using a 12hr clock (AM/PM) or 24hr clock (military time). Save by touching the Done button when finished. NOTE: When registering the OmniLogic and creating a web account, you'll be prompted to enter a Time Zone. Be sure to enter the same time zone as the physical location of the OmniLogic, otherwise schedules and timers will be inaccurate.

Select Desired Units of Measure - If Standard is selected, temperatures will be displayed in Fahrenheit. If Metric is selected, temperatures will be displayed in Celsius.



MSP ID - The OmniLogic MSP ID number will be displayed. This unique number is used to identify your OmniLogic when setting up a web account. A web account is needed to access the OmniLogic over the web by mobile devices. **IMPORTANT:** write down the MSP ID number for future use. The MSP ID number will be needed when entering the configuration wizard after initial configuration as well as entering and exiting Simple Mode. Simple Mode is a customizable screen that can be set up for quick access to pool/spa functions and features.

How many Bodies of Water? The OmniLogic can support one or two bodies of water, typically a pool and spa. Select the number and advance. You'll be brought to a screen where you can add, delete or edit a Body of Water. When initially configuring the OmniLogic, a "?" will appear in the Body of Water button. You will have to configure this body of water by selecting it and then touching the Advance button. When finished configuring bodies of water, you'll be returned to this same screen. Touch the Done button and advance to the next section of configuration.

IMPORTANT: The following instructions are for Body of Water 1 configuration. When finished with the first Body of Water, you'll follow the same instructions for the second Body of Water. When configuring the second Body of Water, you'll have the option of using "Shared Equipment". If Shared Equipment is enabled, the second Body of Water will use the filter pump as well as other equipment (heater, chlorinator, etc.) that has been assigned to the first Body of Water. Additionally, you will have the option for using "Shared Heaters". If you have dual equipment with shared heaters, this can be configured from the second Body of Water's configuration menu. See page 33 for more information regarding Shared Equipment in the second Body of Water configuration menu.

What is the Body of Water type? Select the type of Body of Water that you would like to configure. The choices are Pool and Spa.

Name of Body of Water - Selecting the box will allow you to edit the name. During initial configuration, the box will be blank. Select the box and then use the keyboard to enter the desired name of the body of water.

Size of Body of Water - Enter the Body of Water size in gallons. If you're not certain the size of your pool, refer to the chart on page 21 to help determine the pool capacity.

How Many Filter Pumps? - This question is for THIS BODY OF WATER ONLY. For example: If you have 2 pumps; one for the pool Body of Water and one for the spa Body of Water, you would answer "1" to this question.

If "1" or more is selected:

Name Filter Pump - Touch the box and use the keyboard to name the filter pump.

What Type - Depending on your answer, the OmniLogic will use one relay (single speed pumps), two relays (two speed pumps) or the low speed communication bus (VSP pumps) for pump control. Select the type of pump and advance.

If one speed or two speed pump is selected:

Which Relay is it Wired to? If using a single speed or two speed pump, you'll be asked which relay(s) is wired to the pump. If a value is already shown in the box(es), advance to the next screen. If no value is shown, selecting the box will bring you to a table showing all detected relays. Select the proper relay(s) from the table and touch the Done button to proceed. The relay(s) should now be shown in the box(es) and you can advance to the next screen to continue the pump configuration.

Filter Pump Off for Valve Change? When Yes is selected, the pump will shut off for 35 seconds whenever the valve(s) change position.

Flow Monitoring Enabled? *Requires use of a Hayward flow switch.* This feature will help protect the filter pump from damage due to no flow. When Yes is selected, the OmniLogic will monitor the state of water flow when the filter pump is on. If no flow is detected for more than 20 minutes, the OmniLogic will shut down the pool pump and will indicate an error. The error will be cleared the next time the pump is turned on.

Would You Like to Enable Priming? Select whether you want the filter pump to prime when turned on. This will turn the pump on at high speed for a set amount of time to establish normal water flow every time the pump is activated after being off for at least 30 seconds. If Yes is selected, the following screen will allow you to choose the length of time the pump will prime. This option only appears if the filter pump is configured as a 2-Speed pump.

Freeze Protection Enabled? Freeze protection is used to protect the pool and plumbed equipment against freeze damage during cold temperatures. If freeze protection is enabled AND the air temperature falls below the freeze threshold, the OmniLogic will turn on the filter pump to circulate the water. If two Bodies of Water are configured, the valves will also alternate between the pool and spa every 30 minutes and the filter pump will turn off while the valves are turning. The chlorinator will not operate if freeze protection is the only reason the pump is running.

If Yes is selected:

Freeze Protection Temperature? Select the temperature to be used for freeze protection. Temperature is adjustable from 33°F-42°F (1°C-6°C). 38°F (3°C) is default. This threshold will be used for all outputs that have freeze protection enabled.

If VSP is selected:

Which Hayward Unique Address? If using a VSP, you'll be asked what is the Hayward Unique Address (HUA). If a value is already shown in the box, advance to the next screen. If no value is shown, selecting the box will bring you to a table showing all detected



HAYWARD®

devices. Select the proper HUA from the table and touch the Done button. If unsure of the HUA, refer to the pump's manual for instructions on how to determine the pump's HUA. Once selected, the address should now be shown in the box and you can advance to the next screen to continue the VSP configuration.

Pump Capacity - Set the minimum and maximum RPM of the pump. Refer to your pump manual for more information.

Permitted User Setting - The OmniLogic will automatically calculate these values based on the minimum and maximum RPM that were previously entered. They can be changed as desired.

Speed Presets - Set the Low Pump Speed %, Medium Pump Speed %, and High Pump Speed %, presets. These presets will be used when setting schedules for your pump.

Filter Pump Off for Valve Change? When Yes is selected, the pump will shut off for 35 seconds whenever the valve(s) change position.

Flow Monitoring Enabled? *Requires use of a Hayward flow switch.* This feature will help protect the filter pump from damage due to no flow. When Yes is selected, the OmniLogic will monitor the state of water flow when the filter pump is on. If no flow is detected for more than 15 minutes, the OmniLogic will shut down the pool pump and will indicate an error. The error will be cleared the next time the pump is turned on.

Would You Like to Enable Priming? Select whether you want the filter pump to prime when turned on. This will turn the pump on at high speed for a set amount of time to establish normal water flow every time the pump is activated after being off for at least 30 seconds. If Yes is selected, the following screen will allow you to choose the length of time the pump will prime.

Freeze Protection Enabled? Freeze protection is used to protect the pool and plumbed equipment against freeze damage during cold temperatures. If freeze protection is enabled AND the air temperature falls below the freeze threshold, the OmniLogic will turn on the filter pump to circulate the water. If two Bodies of Water are configured, the valves will also alternate between the pool and spa every 30 minutes and the filter pump will turn off while the valves are turning. The chlorinator will not operate if freeze protection is the only reason the pump is running.

If Yes is selected:

Freeze Protect Temperature? Select the temperature to be used for freeze protection. Temperature is adjustable from 33°F-42°F (1°C-6°C). 38°F (3°C) is default. This threshold will be used for all outputs that have freeze protection enabled.

Freeze Protect Speed? This is the speed of the pump while freeze protection is active. Select the desired pump speed %.

How many Heaters? This question is for THIS BODY OF WATER ONLY. For example: If you have 2 heaters, one for the pool Body of Water and one for the spa Body of Water, you would answer "1" to this question. Note that you can have a maximum of 5 heaters/chillers per Body of Water.

If "1" or more is selected:

Heater Cooldown Enabled? This feature ensures that the heater cools down before water circulation is stopped. When enabled, the OmniLogic will continue to run the filter pump for 5 minutes after the heater turns off.

Heater Extend Enabled? If "Enabled", the filter extend logic keeps the filter pump running beyond the normal turn-off time until the pool (or spa) is heated up to the desired temperature setting. Heater extend will NOT cause the filter pump to turn on, it will only delay the turn off time when the heater is operating.

Settable Water Temperature Range? This is the maximum and minimum allowed settings for heating and/or cooling.

Select and Configure a Heater At this screen, you can add, delete and configure your heater(s). Select the desired heater, then touch the Advance button. When finished configuring heater(s), you'll be returned to this same screen. Touch the Done button and advance to the next section of configuration. Refer to the following information when configuring heater(s):

Do you want to configure a Smart Heater? This option only appears if you have a heater with OmniLogic remote control capability connected to your OmniLogic and powered on. Select "Yes" if you would like to configure this heater now or "No" if you would like to configure a different heater.

If Yes is selected:

Which Hayward Unique Address? Select the HUA of the Smart Heater that you would like to configure.

Name Heater Select the box, then type the desired name for your heater. This name will be used when referring to this particular heater.



HAYWARD®

Does Heater Have a Valve? Select whether or not the heater has an associated valve that will turn on when the heater is activated. If *Yes* is selected, the following screen will ask where the valve is wired (refer to Connection Table for this information).

Minimum Allowed Air Temperature for Heater? If the air temperature falls below this setting, the heater will be prevented from running, regardless of conditions. This feature is especially useful for heat pumps which become less efficient as the outdoor ambient temperature falls.

Minimum Operation Speed? For variable speed pumps, select the lowest pump speed that is allowed while heating. Set a speed that will ensure that there will be sufficient flow for the heater to operate properly. For two speed pumps, you can select if you want to allow the filter pump to run at low speed during heater operation.

What Type? Heater choices are Solar, Heat Pump, Gas, Geothermal, and Electric. Make your selection and advance.

If Gas or Electric Heater is selected:

Name Heater Select the box, then type the desired name for your heater. This name will be used when referring to this particular heater.

Which Relay is it Wired to? Selecting the box will bring you to a table showing all detected relays. Select the low voltage relay that is wired to the heater (refer to the Connection Table for this information), then advance. The relay should now be shown in the box. Advance to the next screen to continue gas heater configuration.

Does Heater Have a Valve? Select whether or not the heater has an associated valve that will turn on when the heater is activated. If *Yes* is selected, the following screen will ask where the valve is wired (refer to Connection Table for this information).

Heater Priority Duration? This question will appear if more than one heater is configured. Set the amount of time that you will allow the priority heater to heat before allowing the next heater to start. If the priority heater meets the demand within this time frame, the next heater will not be used. Note that a time interval setting of "0" will eliminate priority and always run both heaters at the same time. If a time interval setting of "24" is selected, the next priority heater will not turn on until the first priority heater becomes invalid to run.

Minimum Operation Speed? For variable speed pumps, select the lowest pump speed that is allowed while heating. Set a speed that will ensure that there will be sufficient flow for the heater to operate properly. For two speed pumps, you can select if you want to allow the filter pump to run at low speed during heater operation.

If Heat Pump or Geothermal is selected:

Name Heater Select the box, then type the desired name for your heater. This name will be used when referring to this particular heater.

Which Relay is it Wired to? Selecting the box will bring you to a table showing all detected relays. Select the low voltage relay that is wired to the heater (refer to the Connection Table for this information), then advance. The relay should now be shown in the box. Advance to the next screen to continue heat pump configuration.

Does Heater Have a Valve? Select whether or not the heater has an associated valve that will turn on when the heater is activated. If *Yes* is selected, the following screen will ask where the valve is wired (refer to Connection Table for this information).

Does Heater Support Cooling? If your Heat Pump or Geothermal Heater supports cooling and you would like to use it to chill your pool/spa water, select *Yes* to this question. If *Yes* is selected, the following screen will ask where the cooling relay is located (refer to Connection Table for this information).

Heater Priority Duration? This question will appear if more than one heater is configured. Set the amount of time that you will allow the priority heater to heat before allowing the next heater to start. If the priority heater meets the demand within this time frame, the next heater will not be used. Note that a time interval setting of "0" will eliminate priority and always run both heaters at the same time. If a time interval setting of "24" is selected, the next priority heater will not turn on until the first priority heater becomes invalid to run.

Minimum Allowed Air Temperature for Heater? (Heat Pump Only) If the air temperature falls below this setting, the heater will be prevented from running, regardless of conditions. This feature is especially useful for heat pumps which become less efficient as the outdoor ambient temperature falls.

Minimum Operation Speed? For variable speed pumps, select the lowest pump speed that is allowed while heating. Set a speed that will ensure that there will be sufficient flow for the heater to operate properly. For two speed pumps, you can select if you want to allow the filter pump to run at low speed during heater operation.



HAYWARD®

If Solar is selected:

Name Heater Select the box, then type the desired name for your heater. This name will be used when referring to this particular heater.

Does the Solar Heater Have a Pump? Select whether the solar heating system has a dedicated recirculation pump. If so, the OmniLogic will turn this pump on when the pool temperature is below the heater setting and there is solar heat available.

If Yes is selected:

Which Relay is it Wired to? Selecting the box will bring you to a table showing all detected relays. Select the high voltage relay that is wired to the heater (refer to the Connection Table in for this information), then advance. The relay should now be shown in the box. Advance to the next screen to continue solar heater configuration.

Does the Solar Heater Have a Valve? Select whether the solar heating system has a diverter valve to route pool/spa water through the solar collectors. If so, the OmniLogic will rotate this valve when the pool temperature is below the heater setting and there is solar heat available.

If Yes is selected:

Where is the valve wired? Selecting the box will bring you to a table showing all detected low voltage relays. Select the relay that is wired to the solar valve, then advance. The relay should now be shown in the box. Advance to the next screen to continue solar heater configuration.

Where is the Solar Temperature Sensor Located? Selecting the box will bring you to a table showing all detected sensors. Select the solar sensor (usually SENS3), then advance. The sensor should now be shown in the box. Advance to the next screen to continue solar heater configuration.

Heater Priority Duration? This question will appear if more than one heater is configured. Set the amount of time that you will allow the priority heater ("1") to heat before allowing the next heater to start. If the priority heater meets the demand within this time frame, the next heater will not be used. Note that a time interval setting of "0" will eliminate priority and always run both heaters at the same time. If a time interval setting of "24" is selected, the next priority heater will not turn on until the first priority heater becomes invalid to run.

Does Solar Require the Filter Pump to Prime When it First Turns On? If *Yes* is selected, the filter pump will turn on in high speed for 3 minutes to circulate water to the solar panels when the heater is activated. This setting is especially useful if you do not have a boost pump to push the pool/spa water to the roof.

Minimum Operation Speed? Select the lowest pump speed that is allowed while solar heating. Set a speed that will ensure that there will be sufficient flow for the solar heating system to operate properly. For two speed pumps, you can select if you want to allow the filter pump to run at low speed during heater operation.

Would You Like To Prioritize The Use Of Solar Heating Over Any Other Types? Select *Yes* if you would like your solar heater to always be the number 1 heater priority if multiple heaters are configured.

How Many Chillers? This question is for THIS BODY OF WATER ONLY. For example: If you have 2 chillers, one for the pool and one for the spa, you would answer "1" to this question. Note that you can have a maximum of 5 heaters/chillers per Body of Water.

If "1" or more is selected:

Name Chiller Select the box, then type the desired name for your chiller. This name will be used when referring to this particular chiller.

Is Chiller Wired to a Relay? Select whether or not the chiller is wired to a relay. If *Yes* is selected, the following screen will ask you to select where the relay is wired (refer to Connection Table for this information).

Does Chiller Have a Valve? Select whether or not the chiller has an associated valve. If *Yes* is selected, the following screen will ask you to select where the valve is wired (refer to Connection Table for this information).

Chiller Priority Duration? This question will appear if more than one chiller is configured. Set the amount of time that you will allow the priority chiller to cool before allowing the next chiller to start. If the priority chiller meets the demand within this time frame, the next chiller will not be used. Note that a time interval setting of "0" will eliminate priority and always run both chillers at the same time. If a time interval setting of "24" is selected, the next priority chiller will not turn on until the first priority chiller becomes invalid to run.

Minimum Operation Speed? Select the lowest pump speed that is allowed while solar heating. Set a speed that will ensure that there will be sufficient flow for the solar heating system to operate properly. For two speed pumps, you can select if you want to allow the filter pump to run at low speed during heater operation.



Do you have a Sense & Dispense Module? Select Yes if a Hayward HL-CHEM (sold separately) is connected to the OmniLogic.

If Yes is selected:

The next few screens will configure the OmniLogic to use Sense and Dispense. The OmniLogic automatically detects smart components like the HL-CHEM, and assigns a Hayward Unique Address. If multiple components are detected, the OmniLogic will show a table of devices and prompt you to select the proper device.

Which Hayward Unique Address? If a Hayward Unique Address (HUA) is already shown in the box, touch the Advance button. If no address is shown, selecting the box will bring you to a table showing all detected Sense and Dispense devices. Select the HL-CHEM from the table and touch the Done button to advance. The address should now be shown. Touch the Advance button to continue configuring the OmniLogic for use with the HL-CHEM.

Does ORP Control Chlorination? If you say Yes to this, the HL-CHEM will constantly measure ORP and will adjust the pool's chlorine based on a predetermined setpoint that you will select. The system will monitor ORP and automatically generate/dispense the correct amount of chlorine to maintain a desired level. Alternatively, if you say No to this question and select a TurboCell, the HL-CHEM will monitor ORP, but the amount of chlorine generated will be based on a manual setting that you will select.

If Yes is selected:

ORP Setpoint - Set the desired ORP level which is measured in mV. 650mV is the default. The OmniLogic will continuously measure ORP and generate/dispense the proper amount of chlorine to maintain this setpoint.

ORP Timeout - Select a timeout interval. If the OmniLogic has been chlorinating for more than the selected ORP timeout without reaching the desired level, the chlorinator will turn off and display an alarm. The user must clear the alarm to resume chlorination.

Type of Chlorinator? Select the Hayward TurboCell model, liquid chlorinator or tablet feeder that is installed in your system. A flow switch must be installed when using a chlorinator.

If TurboCell model is selected (requires a connected Hayward TurboCell or AquaRite with HLAQRPCB communication board):

Select Salt Monitoring Level - Select Standard Salt or Low Salt. If running the system using a low salt level (1200 PPM-1800 PPM, 1500 PPM optimal) select Low Salt. If running the system using standard salt level (2700 PPM - 3400 PPM, 3200 PPM optimal), select Standard Salt.

Where is the Cell Located? If an entry is already shown in the box, touch the Advance button. If no entry is shown, selecting the box will bring you to a table showing the detected cells. The OmniLogic will detect a directly connected TurboCell and/or a TurboCell that is connected to an AquaRite (requires HLAQRPCB communication board). The table will display "Main Panel" under device type for directly connected TurboCells and "AquaRite", if a AquaRite is used.

If Liquid Chlorinator is selected:

Select Relay - Selecting the box will bring you to a table showing all HV relays. Find the relay that is connected to the Liquid Chlorinator. Select the relay and select Done.

If Tablet Feeder is selected:

Where is the Valve Wired? - Selecting the box will bring you to a table showing all valve outputs. Find the valve that is connected to the Tablet Feeder. Select the valve and select Done.

If No is selected:

Do You Have a Salt Water Chlorine Generator? (requires a connected Hayward TurboCell or AquaRite with HLAQRPCB communication board)

If Yes is selected:

Type of Cell? Select the type of Hayward TurboCell that is installed in your system.

Where is the Cell Located? If an entry is already shown in the box, touch the Advance button. If no entry is shown, selecting the box will bring you to a table showing the detected cells. The OmniLogic will detect a directly connected TurboCell and/or a TurboCell that is connected to an AquaRite (requires HLAQRPCB communication board). The table will display "Main Panel" under device type for directly connected TurboCells and "AquaRite", if a AquaRite is used.

Percentage of Output - The OmniLogic can only generate chlorine while the filter pump is operating. Set the percentage of run time that you desire chlorine generation. Raise this value to generate more chlorine. Lower this value to generate less.

Is pH Reduction Enabled? Select Yes if you have a dispenser to lower pH connected to the OmniLogic.

If Yes is selected:

Are you Using Acid or CO₂? Select one.

How Many Acid/CO₂ Dispensers? Select the number of Acid/CO₂ dispensers in your system.



HAYWARD®

Which relay is it Wired to? Select the box to advance to the High Voltage Table. This table lists all of the high voltage relays that are installed in the OmniLogic. Select the relay that is wired to the pH dispense unit. Refer to the Connection Table for this information.

pH Setpoint - Selecting the box will allow you to change the setpoint (7.5 default). Touch the Advance button when finished.

pH Dispensing Timeout - Select a timeout interval. If the unit has been dispensing for more than the selected timeout without reaching the desired level, pH dispensing will turn off and an alarm will be displayed. Check the chemical supply and the feeder. If both are OK, the timeout may need to be increased. The user must clear the alarm to resume pH dispensing.

pH Extend Enabled - If enabled, the OmniLogic will continue to run the filter pump regardless of schedule until the pH level in the pool has reached the setpoint.

How Many Cleaners? - This question is for THIS BODY OF WATER ONLY. For example: If you have 2 cleaners; one for the pool Body of Water and one for the spa Body of Water, you would answer "1" to this question.

If "1" or more is selected:

Select and Configure a Cleaner At this screen you can add, delete and configure your cleaner(s). Select the desired cleaner, then touch the Advance button. When finished configuring cleaner(s), you'll be returned to this same screen. Touch the Done button to advance to the next section of configuration. Refer to the following information when configuring cleaner(s):

Type of Cleaner? Touch the box and select the type of cleaner used. Choices are Pressure, Suction, Robotic and In-Floor.

Name of Cleaner - Touch the box and use the keyboard to name the cleaner.

Does Cleaner Have a Pump? Select whether the cleaner has a dedicated pump. If so, the OmniLogic will turn this pump on when the cleaner is scheduled to run.

If Yes is selected:

What Type? Select the type of pump used. The choices are Single Speed, Two Speed and VSP.

If single speed or two speed pump is selected:

Which Relay is it Wired to? If using a single speed or two speed pump, you'll be asked which relay(s) is wired to the pump. If a value is already shown in the box(es), advance to the next screen. If no value is shown, selecting the box will bring you to a table showing all detected relays. Select the proper relay(s) from the table and touch the Done button. The relay should now be shown in the box(es) and you can advance to the next screen to continue the pump configuration.

Would You Like to Enable Priming? Select whether you want the pump to prime when turned on. This will turn the pump on at high speed for a set duration to establish normal water flow every time the pump is activated after being off for at least 30 seconds. This option only appears if the pump is configured as a 2-Speed pump.

If VSP is selected:

Which Hayward Unique Address? If using a VSP for your cleaner pump, you'll be asked what is the Hayward Unique Address (HUA). If a value is already shown in the box, advance to the next screen. If no value is shown, selecting the box will bring you to a table showing all detected devices. Select the proper HUA from the table and touch the Done button. The address should now be shown in the box and you can advance to the next screen to continue the VSP configuration.

Pump Capacity - Set the minimum and maximum RPM of the pump. Refer to your pump manual for more information.

Permitted User Setting - The OmniLogic will automatically calculate these values based on the minimum and maximum RPM that were previously entered. They can be changed as desired.

Speed Presets - Set the Low Pump Speed %, Medium Pump Speed %, and High Pump Speed %, presets. These presets will be used when setting schedules for your pump.

Would You Like to Enable Priming? Select whether you want the pump to prime when turned on. This will turn the pump on at high speed for a set duration to establish normal water flow every time the pump is activated after being off for at least 30 seconds.

Does Cleaner have a Valve? Select whether the cleaner requires a valve to change position when in use.

If Yes is selected:

How Many? Select how many valves are used for the cleaner.



Where is the Valve(s) Wired? Selecting the box will bring you to a table showing all detected low voltage relays. Select the relay(s) that is wired to the cleaner valve(s), then advance. The valve(s) should now be shown in the box(es). Advance to the next screen to continue cleaner configuration.

Would you like your valve(s) to cycle On and Off at a set interval? If you would like the cleaner valve(s) to cycle to a set interval while cleaning, select Yes. Set the interval on the next screen.

Freeze Protection Enabled? Freeze protection is used to protect the pool and plumbed equipment against freeze damage during cold temperatures. If freeze protection is enabled AND the air temperature falls below the freeze threshold (refer to pump configuration), the OmniLogic will turn on the cleaner pump to circulate the water.

How Many Water Features? - This question is for THIS BODY OF WATER ONLY. For example: If you have 2 water features; one for the pool Body of Water and one for the spa Body of Water, you would answer "1" to this question.

If "1" or more is selected:

Select and Configure a Water Feature At this screen you can add, delete and configure your water features. Select the desired water feature, then touch the Advance button. When finished configuring water features, you'll be returned to this same screen. Touch the Done button and advance to the next section of configuration. Refer to the following information when configuring water features:

Type of Water Feature? Touch the box and select the type of water feature used. Choices are Water Feature, Water Slide, Waterfall, and Fountain.

Name of Water Feature - Touch the box and use the keyboard to name the water feature.

Does Water feature Have a Pump? Select whether the water feature has a dedicated pump. If so, the OmniLogic will turn this pump on when the water feature is scheduled to run.

If Yes is selected:

What Type? Select the type of pump used. The choices are Single Speed, Two Speed and VSP.

If single speed or two speed pump is selected:

Which Relay is it Wired to? If using a single speed or two speed pump, you'll be asked which relay(s) is wired to the pump. If a value is already shown in the box(es), advance to the next screen. If no value is shown, selecting the box will bring you to a table showing all detected relays. Select the proper relay(s) from the table and touch the Done. The relay(s) should now be shown in the box(es) and you can advance to the next screen to continue the pump configuration.

Would You Like to Enable Priming? Select whether you want the pump to prime when turned on. This will turn the pump on at high speed for a set duration to establish normal water flow every time the pump is activated after being off for at least 30 seconds. This option only appears if the pump is configured as a 2-Speed pump.

If VSP is selected:

Which Hayward Unique Address? If using a VSP for your water feature pump, you'll be asked what is the Hayward Unique Address (HUA). If a value is already shown in the box, advance to the next screen. If no value is shown, selecting the box will bring you to a table showing all detected devices. Select the proper HUA from the table and touch the Done button. If unsure of the HUA, refer to the pump's manual for instructions on how to determine the pump's HUA. Once selected, the address should now be shown in the box and you can advance to the next screen to continue the VSP configuration.

Pump Capacity - Set the minimum and maximum RPM of the pump. Refer to your pump manual for more information.

Permitted User Setting - The OmniLogic will automatically calculate these values based on the minimum and maximum RPM that were previously entered. They can be changed as desired.

Speed Presets - Set the Low Pump Speed %, Medium Pump Speed %, and High Pump Speed %, presets. These presets will be used when setting schedules for your pump.

Would You Like to Enable Priming? Select whether you want the pump to prime when turned on. This will turn the pump on at high speed for a set duration to establish normal water flow every time the pump is activated after being off for at least 30 seconds.

Water Feature Wired to a Relay? Select whether the water feature requires the use of a high voltage relay.

If Yes is selected:

Select Relay - Touching the box will bring you to a table showing all detected relays. Select the relay(s) that is connected to the water feature and touch the Done button. The relay should now be shown in the box and you can advance to the next screen to continue water feature configuration.



HAYWARD®

Does Water Feature have a Valve? Select whether the water feature requires a valve to change position when in use.

If Yes is selected:

How Many? Select how many valves are used for the water feature.

Where is the Valve(s) Wired? Selecting the box will bring you to a table showing all detected low voltage relays. Select the relay(s) that is wired to the water feature valve(s), then advance. The valve(s) should now be shown in the box. Advance to the next screen to continue water feature configuration.

Freeze Protection Enabled? Freeze protection is used to protect the pool and plumbed equipment against freeze damage during cold temperatures. If freeze protection is enabled AND the air temperature falls below the freeze threshold (refer to pump configuration), the OmniLogic will turn on the water feature pump to circulate the water.

If Yes is selected:

Freeze Protect Speed? This is the speed of the pump while freeze protection is active. Select the desired pump speed %. NOTE: this option only appears if the pump is a two speed pump or a variable speed pump.

Would You Like To Configure A Default Startup Speed For Water Feature? If the water feature has a valve and the system uses a VSP filter pump, the OmniLogic allows you to set a startup pump speed for the water feature, regardless of the pump's schedule. The speed will change at the next scheduled interval.

Do You Want to Configure Any Lights? Select yes if you are using any type of pool or spa lights. The options are Universal ColorLogic (UCL), ColorLogic 4.0 (CL4.0), ColorLogic 2.5 (CL2.5), WaterBowl, Pentair Color LED (P-COLOR), Jandy Color LED (Z-Color), Incandescent, and Other. Transformers powering Universal ColorLogic lights must all be connected to the same high voltage relay for synchronization to function properly. If using OmniDirect mode, you must use an internal relay, not an HLRELAYBANK.

If Yes is selected:

What Kind of Lights? Touch the box to select the type of lights that will be used. The options are UCL (14V), CL4.0 (115V), CL2.5 (14V), WaterBowl, P-Color, Z-Color, Incandescent, and Other.

Name the Group of Lights - Touch the box and use the keyboard to name the lights.

How Many Relays are Lights Wired to? Select the number of relays used by the lights.

Which Relay is it Wired to? Touching the box(es) will bring you to a table showing all detected relays. Select the relay(s) that are connected to the lights. If the lights are connected to a Smart Power Transformer, select the zone(s) that the lights are wired to. Once the relay(s) are selected, touch the Done button. The relay(s) should now be shown in the box(es) and you can advance to the next screen to continue the configuration.

If UCL was previously selected:

Would you like to test for OmniDirect capability? For UCL lights manufactured after June 2018, you can select Yes and the OmniLogic will test your lights to confirm. If your lights blink white after the test, you can enable OmniDirect mode. If not, the UCL light will default to UCL Standalone mode. Note that if you are configuring a WaterBowl light, the Flicker feature will only be available if the light is set to OmniDirect mode.

How Many Accessories? Select the number of accessories that will be used for this Body of Water only. You'll have an opportunity to configure accessories for the spa and also the backyard at a later point.

If "1" or more is selected:

Select and Configure Accessories At this screen you can add, delete and configure your accessories. Select the desired accessory, then touch the Advance button. When finished configuring accessories, you'll be returned to this same screen. Touch the Done button and advance to the next section of configuration. Refer to the following information when configuring accessories:

Type of Accessory? Touch the box and select the type of accessory used. Choices are Laminars, Jets, Blower and Other.

Name of Accessory - Touch the box and use the keyboard to name the accessory.

Does Accessory Have a Pump? Select whether the accessory has a dedicated pump. If so, the OmniLogic will turn this pump on when the accessory is scheduled to run.

If Yes is selected:

What Type? Select the type of pump used. The choices are Single Speed, Two Speed and VSP.

If single speed or two speed pump is selected:

Which Relay is it Wired to? If using a single speed or two speed pump, you'll be asked which relay(s) is wired to the pump. If a value is already shown in the box(es), advance to the next screen. If no value is shown, selecting the box will bring you to a table showing all detected relays. Select the proper relay(s) from the table and touch the Done button. The relay(s)



should now be shown in the box(es) and you can advance to the next screen to continue the pump configuration.

Would You Like to Enable Priming? Select whether you want the pump to prime when turned on. This will turn the pump on at high speed for 3 minutes to establish normal water flow every time the pump is activated after being off for at least 30 seconds. This option only appears if the pump is configured as a 2-Speed pump.

If VSP is selected:

Which Hayward Unique Address? If using a VSP for your accessory pump, you'll be asked what is the Hayward Unique Address (HUA). If a value is already shown in the box, advance to the next screen. If no value is shown, selecting the box will bring you to a table showing all detected devices. Select the proper HUA from the table and touch the Done button. The address should now be shown in the box and you can advance to the next screen to continue the VSP configuration.

Pump Capacity - Set the minimum and maximum RPM of the pump. Refer to your pump manual for more information.

Permitted User Setting - The OmniLogic will automatically calculate these values based on the minimum and maximum RPM that were previously entered. They can be changed as desired.

Speed Presets - Set the Low Pump Speed %, Medium Pump Speed %, and High Pump Speed %, presets. These presets will be used when setting schedules for your pump.

Would You Like to Enable Priming? Select whether you want the pump to prime when turned on. This will turn the pump on at high speed for a set duration to establish normal water flow every time the pump is activated after being off for at least 30 seconds.

Accessory Wired to Relay? Select whether the accessory requires the use of a high voltage relay.

If Yes is selected:

Select Relay - Touching the box will bring you to a table showing all detected relays. Select the relay that is connected to the accessory and touch the Done button. The relay should now be shown in the box and you can advance to the next screen to continue the accessory configuration.

Does Accessory have a Valve? Select whether the accessory requires a valve to change position when in use.

If Yes is selected:

How Many? Select how many valves are used for the accessory.

Where is the Valve(s) Wired? Selecting the box will bring you to a table showing all detected low voltage relays. Select the relay(s) that is wired to the accessory valve(s), then advance. The valve(s) should now be shown in the box. Advance to the next screen to continue accessory configuration.

Freeze Protection Enabled? Freeze protection is used to protect the pool and plumbed equipment against freeze damage during cold temperatures. If freeze protection is enabled AND the air temperature falls below the freeze threshold (refer to pump configuration), the OmniLogic will turn on the accessory pump to circulate the water.

If Yes is selected:

Freeze Protect Speed? This is the speed of the pump while freeze protection is active. Select the desired pump speed %. NOTE: this option only appears if the pump is a two speed pump or a variable speed pump.

Would You Like To Configure A Default Startup Speed For the Accessory? If the accessory has a valve and the system uses a VSP filter pump, the OmniLogic allows you to set a startup pump speed for the accessory, regardless of the pump's schedule. The speed will change at the next scheduled interval.

NOTE: The following configuration settings are specific to the second Body of Water regarding Shared Equipment and Dual Equipment with shared heaters setup.

As you advance through the second Body of Water's configuration settings, note that most of the questions asked are the same as the first Body of Water with the exception of the following:

Does Body of Water 2 share its equipment with Body of Water 1?

If Yes is selected:

Your system will be "fully shared" which means your filter pump/heaters/chemistry will be shared between both Bodies of Water. You can now set your filter pump and heater settings for this body of water.

If No is selected:

You will begin dual equipment setup for you second Body of Water. This means that your filter pump and chemistry will not be shared between both Bodies of Water, but you will still have the option of configuring shared heaters and spillover. You can now configure a filter pump and heaters for this body of water.



HAYWARD®

Are any of Body of Water 2's heaters shared with Body of Water 1?

If Yes is selected:

Which body of water is heated in the event that both are running? Select the Body of Water that you would like to have heating priority if both Bodies of Water are running. This question only appears if you have a Pool/Pool or Spa/Spa setup. If you have a Pool/Spa setup, then the Spa Body of Water will automatically have heating priority.

Select Shared Heater Valves - Select Body of Water 1's return valve, Body of Water 2's return valve, and the Heater return valve in your system. The selections will also affect spillover operation.

Select the heaters you wish to share - Select the heaters that you configured in Body of Water 1 that you would like to be shared with Body of Water 2 and press advance.

Does this body of water have any additional heaters? Select whether you have any additional heaters in Body of Water 2 that you would like to configure that are not shared with Body of Water 1.

Do you have Spillover? Select yes to this question if you have Spillover in your system. If yes is selected, choose the valves that will operate Spillover from the following screen.

NOTE: The remaining configuration settings are not specific to a Body of Water.

Do You Have an Air Temperature Sensor? Select whether there is an air temperature sensor wired to the OmniLogic.

If Yes is selected:

Where is the Sensor Wired?

Touching the box will bring you to a table showing all detected sensors connections. Select the sensor connection used for the air sensor (typically SENS2) and touch the Done button. The sensor connection should now be shown in the box and you can advance to the next screen to continue configuration.

Do You Have a Water Temperature Sensor? Select whether there is a water temperature sensor wired to the OmniLogic.

If Yes is selected:

Where is the Sensor Wired?

Touching the box will bring you to a table showing all detected sensors connections. Select the sensor connection used for the water sensor (typically SENS1) and touch the Done button. The sensor connection should now be shown in the box and you can advance to the next screen to continue configuration.

Do You Have a Flow Switch? Select whether there is a flow switch wired to the OmniLogic.

If Yes is selected:

Where is the Sensor Wired?

Touching the box will bring you to a table showing all detected sensors connections. Select the sensor connection used for the (typically FLOW SWITCH 1) and touch the Done button. The sensor connection should now be shown in the box and you can advance to the next screen to continue configuration.

Select and Configure Sensors At this screen you can add, delete and configure your sensors. Select the desired sensor, then touch the Advance button. When finished configuring sensors, you'll be returned to this same screen. Touch the Done button and advance to the next section of configuration. Refer to the following information when configuring sensors:

Where is the Sensor Located? Touch the box and go to the table showing the Bodies of Water and the Backyard. Select the location where the sensor is installed.

What Type of Sensor? Select the type of sensor. Choices are Air, Water, Flow or Solar.

Name Sensor - Touch the box and use the keyboard to name the sensor.

Where is the Sensor Wired? Touching the box will bring you to a table showing all detected sensors connections. Select the sensor connection used for the sensor and touch the Done button. The sensor connection should now be shown in the box and you can advance to the next screen to continue configuration.

Do You Want to Configure Any Backyard Lights? Select yes if you are using any type of pool, spa or outdoor lights. The options are Universal ColorLogic (UCL), ColorLogic 4.0 (CL4.0), ColorLogic 2.5 (CL2.5), WaterBowl, Pentair Color LED (P-COLOR), Jandy Color LED (Z-Color), Incandescent, and Other. Transformers powering Universal ColorLogic lights must all be connected to the same high voltage relay for synchronization to function properly. If using OmniDirect mode, you must use an internal relay, not an HLRELAYBANK.



If Yes is selected:

What Kind of Lights? Touch the box to select the type of lights that will be used. The options are UCL (14V), CL4.0 (115V), CL2.5 (14V), WaterBowl, P-Color, Z-Color, Incandescent, and Other.

Name the Group of Lights - Touch the box and use the keyboard to name the lights.

How Many Relays are Lights Wired to? Select the number of relays used by the lights.

Which Relay is it Wired to? Touching the box(es) will bring you to a table showing all detected relays. Select the relay(s) that are connected to the lights. If the lights are connected to a Smart Power Transformer, select the zone(s) that the lights are wired to. Once the relay(s) are selected, touch the Done button. The relay(s) should now be shown in the box(es) and you can advance to the next screen to continue the configuration.

If UCL was previously selected:

Would you like to test for OmniDirect capability? For UCL lights manufactured after June 2018, you can select Yes and the OmniLogic will test your lights to confirm. If your lights blink white after the test, you can enable OmniDirect mode. If not, the UCL light will default to UCL Standalone mode. Note that if you are configuring a WaterBowl light, the Flicker feature will only be available if the light is set to OmniDirect mode.

How Many Accessories are in the Backyard? Select the number of accessories that will be used for the backyard.

If "1" or more is selected:

Select and Configure Accessories At this screen you can add, delete and configure your accessories. Select the desired accessory, then touch the Advance button. When finished configuring accessories, you'll be returned to this same screen. Touch the Done button and advance to the next section of configuration. Refer to the following information when configuring accessories:

Name of Accessory - Touch the box and use the keyboard to name the accessory.

Which Relay is it Wired to? Touching the box will bring you to a table showing all detected relays. Select the relay that is connected to the accessory and touch the Done button. The relay should now be shown in the box and you can advance to the next screen to continue the accessory configuration.

NOTE: Do not use the OmniLogic to control fire pits or any other fire related equipment.

Would You Like to Add an Interlock? An interlock will allow the OmniLogic to turn on or off pool equipment (affected) based on the state of other pool equipment (monitored). An example of this is would be the desire to turn on walkway lighting (affected) every time the pool deck lights (monitored) are turned on. This equipment could have been wired together to accomplish the same function, but by interlocking the walkway lights to the deck lights, you'll maintain the ability to turn on the walkway lights independently. An interlock can also control pool equipment based on the state of a temperature sensor, flow switch or external input (normally open/closed switch). An example of this would be to turn on a cabana fan (affected) whenever the outside temperature sensor reads above 90°F. Or, turning on a bug lamp (affected) when a photo sensor (monitored) detects that it is dusk.

If Yes is selected:

Select an Interlock Type - From this screen, select the type of interlock that you would like to configure. The choices are: Equipment to Equipment, Equipment to Sensor, Equipment to Mode, Theme to Sensor, Spillover to External Input and Pool Cover Interlock. Note that interlocks are only selectable if the equipment/features used in that interlock are available. For example, if there are no Themes configured, the Theme to Sensor interlock is not selectable.

If Equipment to Equipment is selected:

To configure the interlock, you'll be asked a series of questions. The questions will vary depending on the equipment that will be configured and cannot all be covered in this manual. In general, you'll select equipment that will be monitored and equipment that will be affected. The equipment could be pumps, valves, heaters, lights, etc. The affected equipment will activate/deactivate depending on the state of the monitored equipment. Advance through the configuration and when finished, a summary screen will be displayed. The summary will describe how the interlocked equipment will function. Read through the description and make sure the equipment will function as desired.

If Equipment to Sensor is selected:

This interlock is similar to above, but the monitored equipment will be a sensor. The monitored sensor can be any sensor, flow switch or external input that has been configured for use with the OmniLogic. The affected equipment will activate/deactivate depending on the state of the monitored sensor. For flow switch sensors, affected equipment will turn on/off when the flow switch detects flow or no flow. For temperature sensors, affected equipment will activate/deactivate when the temperature is higher or lower than a desired setpoint. For external inputs, affected equipment will turn on/off when the switch is actuated. Advance through the configuration and when finished, a summary screen will be displayed. The summary will describe how the interlocked equipment will function. Read through the description and make sure the equipment will function as desired.

If Equipment to Mode is selected:

With Equipment to Mode interlock, affected equipment will activate/deactivate based on which mode the OmniLogic is in; Pool, Spa or Spillover. You can configure this interlock to turn on/off equipment whenever the OmniLogic goes into one of these available modes. Advance through the configuration and when finished, a summary screen will be displayed. The summary will describe how the interlocked equipment will function. Read through the description and make sure the equipment will function as desired.



If Theme to Sensor is selected (at least one Theme must be configured, see Operation Manual):

This interlock is similar to the Equipment to Sensor interlock but a Theme is affected instead. As explained in the Operation manual, Themes are created to execute many pool functions with a single button. With a Theme to Sensor interlock, the Theme will run or stop depending on the state of the monitored sensor. For flow switch sensors, the Theme will run or stop when the flow switch detects flow or no flow. For temperature sensors, the Theme will run or stop when the temperature is higher or lower than a desired setpoint. For external inputs, the Theme will run or stop when the switch is actuated. Advance through the configuration and when finished, a summary screen will be displayed. The summary will describe how the interlocked Theme will function. Read through the description and make sure the equipment will function as desired.

If Spillover to External Input is selected (requires that you have an external input configured):

This interlock prevents Spillover mode when an external input (most commonly a pool cover sensor) is actuated. By interlocking Spillover to the pool cover sensor, you'll ensure that water cannot spill into the pool when the cover is in the closed position. A summary screen will be displayed after configuring this interlock. Read through the description and make sure the interlock will function as desired.

If Pool Cover Interlock is selected (if using an automatic pool cover):

This interlock makes it easy to assign specific pool settings when the cover is closed. Pump speed, heater temperature and chlorination percentage can all be preset for periods when the pool cover sensor (external input) detects that the cover is closed. Some or all of these options may not appear if you don't have a variable speed pump, heater or if not using chlorination. An alternative to this interlock is using a Theme to Sensor interlock. Create a Theme using desired settings when the pool cover is closed, then interlock the Theme to the pool cover sensor. A summary screen will be displayed after configuring this interlock. Read through the description and make sure the interlock will function as desired.

Configuration Summary The OmniLogic displays all configured equipment in a table for you to view. Scroll through all configured devices and make sure they've been properly assigned.

Finished with Configuration Now that all equipment has been configured, select the following:

Customizing / Add Components - use this selection to go back into Configuration and make changes.

Save and Restart - this selection will save your configuration settings and restart the OmniLogic.

Quick Edit Guide

If additional pool or backyard equipment is added after initial configuration, or you'd like to make a change to an existing configuration setting, re-enter the Configuration Wizard and select "Edit". After selecting "Edit", you will be brought to the Quick Edit Main Menu screen as shown below. Quick Edit allows you to go directly to the equipment that you'd like to add/remove/configure. When you have finished editing the configuration, you will return to this screen to save your changes.

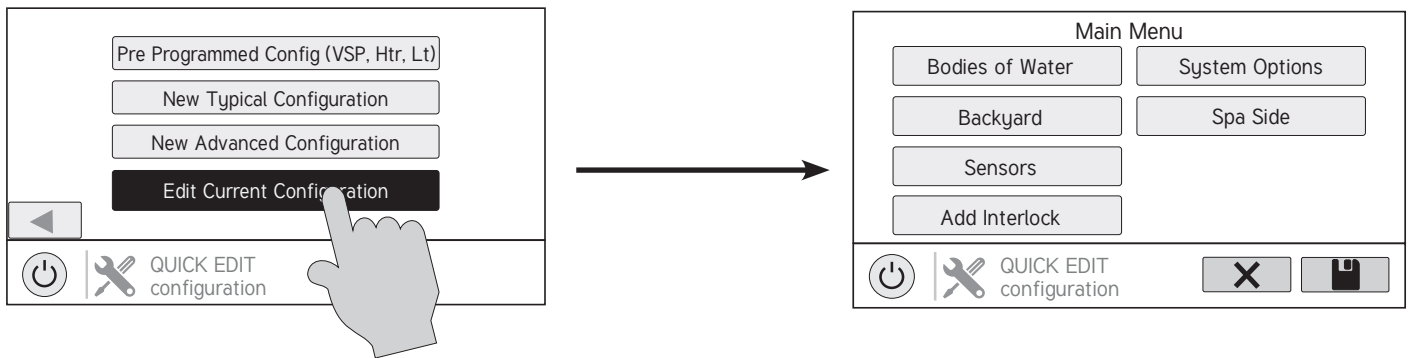



Navigation

There are a number of additional buttons that appear in Quick Edit that either have functions unique to Quick Edit or do not appear anywhere else in the system. These buttons are as follows:



Save - Touch this button to save the configuration edit. This button only appears on the Quick Edit Home screen.



Cancel - Touch this button to cancel any changes made to the configuration and exit Quick Edit. This button only appears on the Quick Edit Home Screen.



Home - Touch this button to quickly jump back to the Quick Edit Main Menu Screen to save your changes. This button appears at the end of every configuration pathway.



Back - Touch this button to go back to the previous set of configurable items.

See page 24 for a full list of buttons that appear during configuration.

As you are using Quick Edit, you will notice that at the end of each pathway, a Home button and a back arrow will appear. If you are finished making changes, press the Home button and then press the Save button to save your configuration. If you would like to make more changes to the same device, press the back arrow. This will take you back to the last screen of configurable items for that device. If you would like to continue to make changes, but to a different device, press the Home button and then follow the pathway to the new device. The following pages will explain each configuration pathway.

Begin Using Quick Edit

From the Quick Main Menu Screen, select one of the following buttons and follow the directions on the next page to configure your equipment.

- Bodies of Water
- Backyard
- Sensors
- Interlocks/Add Interlock
- System Options
- Spa Side

If Bodies of Water is selected:

Select the body of water - Select the Body of Water that you would like to make changes to. Both bodies of water will have the same equipment options for Quick Edit.

Body of Water is selected:

Select the Equipment that you would like to configure - The options are as follows: Filter Pumps, Heaters, Chemistry, Cleaners, Water Features, Standalone Lights, Accessories, and Other Options. If the equipment is not already configured, then the buttons will appear as Add Heater, Add Chemistry, etc. When the button is pressed with the word "Add" before it, then you will be taken through the full configuration for that equipment as appears in the Configuration Wizard portion of this manual. Otherwise:

If Filter Pumps is selected:

Select a Filter Pump - Once you select a filter pump, all of the options for that filter pump will appear on the next screen. These options are as follows:

Name - Rename the Filter Pump to whatever name you desire.

Type - Change the type of Filter Pump that is configured (Single Speed, 2-Speed, or VSP)

HUA - Match the HUA (Hayward Unique Address) to the configured Filter Pump. This option only appears if the Filter Pump is configured as a Variable Speed Pump.

Speed - Change the Minimum and Maximum Allowed Speeds of the Filter Pump as well as the Low, Medium and High speed settings. This option only appears if the Filter Pump is configured as a Variable Speed Pump.

Relay - Select the relay(s) that the Filter Pump is wired to. This option only appears if the Filter Pump is configured as a single speed or 2-Speed pump.

Off for Valve Change - Select whether you want the Filter Pump to shut off while valves are turning.

Flow Monitoring - Select whether you want flow to be monitored in this Body of Water.



HAYWARD®

Priming - Select whether you want the Filter Pump to prime and the desired duration. This option only appears if the Filter Pump is configured as a 2-Speed or Variable Speed Pump.

Freeze Protect - Select whether you want the Filter Pump to turn on for Freeze Protection. Also set the Freeze Protect air temperature threshold from this menu. Freeze protect operation can be overridden for a 60 minute period. (See Operation manual for more information).

If Heating/Cooling is selected:

Add a Heater - Pressing "Add a Heater" from this screen will take you through the full configuration for adding a new heater. These steps are described in the Configuration Wizard portion of this manual.

Add a Chiller - Pressing "Add a Chiller" from this screen will take you through the full configuration for adding a new chiller. These steps are described in the Configuration Wizard portion of this manual.

General Heater Options - Pressing this button will take you to a screen with the following general options for heater operation:

Extend - Select whether you want Heater Extend enabled for this Body of Water.

Cooldown - Select whether you want Heater Cooldown enabled for this Body of Water.

Max Temperature - Select the Maximum Allowed Heater Setpoint Temperature for this Body of Water.

Select a Heater/Chiller - Once you select a heater/chiller, all of the options for that heater/chiller will appear on the next screen. These options are as follows:

Name - Rename the heater/chiller to whatever name you desire.

HUA - Select the HUA of the Smart Heater. This option only appears if a Smart Heater is configured.

Type - Select the type of heater that is configured (Solar, Heat Pump, Gas, Geothermal, Electric).

Relay - Select the relay that the heater/chiller is wired to. Option not available for Solar heaters.

Valve - Configure the heating/cooling valve, if used.

Min Filter Speed - Select the minimum speed that the Filter Pump will run while the heater/chiller is active.

Min Air Temperature - Select the minimum air temperature that the heater will be allowed to run at. This option is only available if the heater is configured as a Heat Pump.

Priority Duration - Select the number of hours that this heater/chiller will run before the next priority heater/chiller turns on.

Pump - Configure the boost pump for the heater. This option is only available if the heater is configured as a Solar heater.

Solar Sensor - Configure the solar sensor. This option is only available if the heater is configured as a Solar heater.

Require Priming - Configure whether or not the filter pump will turn on for 3 minutes to prime during solar heating.

Delete a Heater/Chiller - From this screen, if you wish to delete a heater/chiller that is currently configured, select the trash can on the right of the name of the heater/chiller that you wish to delete.

If Chemistry is selected:

pH - Once you select pH, all of the options for pH dispensing will appear on the next screen. These options are as follows:

Reduction ON - Select whether you want pH reduction to be enabled.

Chemical Type - Select the type of chemical that is being dispensed (acid or CO₂).

pH Dispensers - Configure the pH dispense unit.

pH Timeout - Choose the pH timeout time.

pH Extend - Select whether you want pH extend enabled for this Body of Water.



HAYWARD®

Chem Sense Module - Once you select Chem Sense Module, you will be able to select the HUA of your Chem Sense Module you are using from the next screen.

Chlorination - A flow switch must be installed for this function. Once you select Chlorination, all of the options for chlorination will appear on the next screen. These options are as follows:

Dispenser Type - Select the type of dispenser used (T-CELL model, liquid chlorinator or tablet feeder).

Dispenser Relay or Valve - Depending on your dispenser type, select the output that controls the dispenser.

ORP Timeout - Choose the ORP timeout time and desired ORP setpoint. This option is only available if ORP controls chlorination.

Delete Chem Sense Module/Chlorination - From this screen, if you wish to delete any currently configured chemistry options, select the trash can on the right of the name of the item that you wish to delete.

NOTE: If either pH dispensing or chlorination are not configured, then this screen will give you the option to “Add CSM” or “Add Chlorination.” If either of those options are selected, then you will be taken through the full configuration for that equipment as appears in the Configuration Wizard portion of this manual.

If Cleaners is selected:

Add Cleaner - Pressing “Add Cleaner” from this screen will take you through the full configuration for adding a new cleaner. These steps are described in the Configuration Wizard portion of this manual.

Select a Cleaner - Once you select a cleaner, all of the options for that cleaner will appear on the next screen. These options are as follows:

Name - Rename the cleaner to whatever name you desire.

Type - Select the type of cleaner that is configured (Pressure, Suction, Robotic, In Floor).

Pump - Configure the cleaner pump, if used.

Relay - Select the relay that the cleaner is wired to. This option only appears if the cleaner does not have an associated pump configured.

Valve - Configure the cleaner valve, if used.

Freeze Protect - Select whether you want the cleaner to turn on for Freeze Protection. Also set the Freeze Protect air temperature threshold from this menu.

Valve Cycle - Configure the valve cycling time period for the cleaner. This option is only available if the cleaner has an assigned valve.

Speed - Change the Minimum and Maximum Allowed Speeds of the cleaner as well as the Low, Medium and High speed settings. This option only appears if the cleaner pump is configured as a Variable Speed Pump.

Priming - Select whether you want the cleaner pump to prime and the desired duration. This option only appears if the cleaner pump is configured as a 2-Speed or Variable Speed Pump.

Delete a Cleaner - From this screen, if you wish to delete a cleaner that is currently configured, select the trash can on the right of the name of the cleaner that you wish to delete.

If Water Features is selected:

Add Water Feature - Pressing “Add Water Feature” from this screen will take you through the full configuration for adding a new water feature. These steps are described in the Configuration Wizard portion of this manual.

Select a Water Feature - Once you select a water feature, all of the options for that water feature will appear on the next screen. These options are as follows:

Name - Rename the water feature to whatever name you desire.

Type - Change the type of water feature that is configured (Waterfall, Waterslide, etc.).

Pump - Configure the water feature pump, if used.



HAYWARD®

Relay - Select the relay that the water feature is wired to. This option appears only if the water feature does not have an associated pump configured.

Valve - Configure the water feature valve, if used.

Speed - Change the Minimum and Maximum Allowed Speeds of the water feature pump as well as the Low, Medium and High speed settings. This option only appears if the water feature pump is configured as a Variable Speed Pump.

Priming - Select whether you want the water feature pump to prime and the desired duration. This option is only available if the water feature pump is configured as a 2-Speed or Variable Speed Pump.

Freeze Protect - Select whether you want the water feature to turn on for Freeze Protection. Also set the Freeze Protect air temperature threshold from this menu.

Default Startup Speed - Select the speed that the filter pump will run at when the water feature is turned on.

Delete a Water Feature - From this screen, if you wish to delete a water feature that is currently configured, select the trash can on the right of the name of the water feature that you wish to delete.

If Standalone Lights is selected:

Add Standalone Light - Pressing "Add Standalone Light" from this screen will take you through the full configuration for adding new lights. These steps are described in the Configuration Wizard portion of this manual.

Select an Existing Group of Lights - Once you select a group of existing lights, all of the options for those lights will appear on the next screen. These options are as follows:

Name - Rename the group of lights to whatever name is desired.

Type - Select the type of lights configured.

Relay - Select the relay(s) that the group of lights is wired to. If using a Smart Power Transformer, select the zone(s) that the lights are wired to.

Set Mode - Set the mode of the lights configured.

OmniDirect - If UCL was previously selected, this button will appear and allow you to test whether your UCL lights are OmniDirect compatible (lights built after June 2018). Note that if you are configuring a WaterBowl light, the Flicker feature will only be available if the light is set to OmniDirect mode.

Delete an Existing Group of Lights - From this screen, if you wish to delete a group of lights that is currently configured, select the group and then select the trash can button next to it.

If Accessories is selected:

Add Accessory - Pressing "Add Accessory" from this screen will take you through the full configuration for adding a new accessory. These steps are described in the Configuration Wizard portion of this manual.

Select an Accessory - Once you select an accessory, all of the options for that accessory will appear on the next screen. These options are as follows:

Name - Rename the accessory to whatever name you desire.

Type - Select the type of accessory configured (Laminar, Dimmer, etc.).

Pump - Configure the accessory pump, if used.

Valve - Configure the accessory valve, if used.

Speed - Change the Minimum and Maximum Allowed Speeds of the accessory pump as well as the Low, Medium and High Speed settings. This option only appears if the accessory pump is configured as a Variable Speed Pump.

Priming - Select whether you want the accessory pump to prime and the desired duration. This option is only available if the accessory pump is configured as a 2-Speed or Variable Speed Pump.



HAYWARD®

Freeze Protect - Select whether you want the accessory to turn on for Freeze Protection. Also set the Freeze Protect air temperature threshold from this menu.

Relay - Select the relay that the accessory is wired to. This option only appears if the accessory does not have an associated pump configured.

Default Startup Speed - Select the speed that the filter pump will run at when the water feature is turned on.

Delete an Accessory - From this screen, if you wish to delete an accessory that is currently configured, select the trash can on the right of the name of the accessory that you wish to delete.

If Other Options is selected:

Name - This is where you will be allowed to rename the Body of Water that you are currently configuring to whatever name you desire.

If Backyard is selected:

Select the Equipment that you would like to configure - The options are Add Standalone Light and Add Accessory. The configuration for these are described in the Configuration Wizard portion of this manual.

If Standalone Light is selected:

Add Standalone Light - Pressing "Add Standalone Light" from this screen will take you through the full configuration for adding new lights. These steps are described in the Configuration Wizard portion of this manual.

Select an Existing Group of Lights - Once you select a group of existing lights, all of the options for those lights will appear on the next screen. These options are as follows:

Name - Rename the group of lights to whatever name is desired.

Type - Select the type of lights configured.

Relay - Select the relay(s) that the group of lights is wired to. If using a Smart Power Transformer, select the zone(s) that the lights are wired to.

Set Mode - Set the mode of the lights configured.

OmniDirect - If UCL was previously selected, this button will appear and allow you to test whether your UCL lights are OmniDirect compatible (lights built after June 2018). Note that if you are configuring a WaterBowl light, the Flicker feature will only be available if the light is set to OmniDirect mode.

Delete an Existing Group of Lights - From this screen, if you wish to delete a group of lights that is currently configured, select the group and then select the trash can button next to it.

If Accessories is selected:

Add Accessory - Pressing "Add Accessory" from this screen will take you through the full configuration for adding a new accessory to the Backyard. These steps are described in the Configuration Wizard portion of this manual.

Select an Accessory - Once you select an accessory, all of the options for that Backyard accessory will appear on the next screen. These options are as follows:

Name - Rename the accessory to whatever name is desired.

Relay - Select the relay that the accessory is wired to.

Delete an Accessory - From this screen, if you wish to delete an accessory that is currently configured, select the trash can on the right of the name of the accessory that you wish to delete.

NOTE: The system does not allow you to configure a pump or a valve to accessory equipment in the Backyard.

If Sensors is selected:

Add Sensor - Pressing "Add Sensor" from this screen will take you through the full configuration for adding a new sensor. These steps are described in the Configuration Wizard portion of this manual.

Select a Sensor - Once you select a sensor, all of the options for that sensor will appear on the next screen. These options are as follows:

Name - Rename the sensor to whatever name is desired.



Location - Select the location that the sensor is wired to.

Delete a sensor - From this screen, if you wish to delete a sensor that is currently configured, select the trash can on the right of the name of the sensor that you wish to delete.

If Interlocks is selected:

Add Interlock - Pressing "Add Interlock" from this screen will take you through the full configuration for adding a new interlock. These steps are described in the Configuration Wizard portion of this manual.

Select an Interlock - Selecting an interlock from this screen will allow you to view that interlock's configuration. However, you cannot edit a pre-existing interlock. In order to change an interlock's configuration, you have to delete the obsolete interlock and create a new one.

Delete an Interlock - From this screen, if you wish to delete an interlock that is currently configured, select the trash can on the right of the name of the interlock that you wish to delete.

NOTE: If there are currently no interlocks configured on your system, then the button will appear as "Add Interlock" instead of "Interlocks". In this case, pressing "Add Interlock" will take you through the full configuration for adding a new interlock. These steps are described in the Configuration Wizard portion of this manual. Once an interlock has been created, the button will say "Interlocks".

If System Options is selected:

Modify Network Setup - Press this button to modify or setup a wired, wireless, or external antenna connection.

Would you like to set up a network Connection now? Select the type of connection you would like to set up/modify or select "Not Now". For external antenna connections, you must have a Hayward HLWLAN connected to the OmniLogic. "Wired" requires an ethernet connection to the router.

Wireless - If not connected to a network, selecting this button will run a scan of all available wifi networks. Select the desired network and enter a password to connect. Note that a 2.4GHz connection to the router is required. If already connected to a wifi network, selecting this button will present these four options:

Forget Network - This selection allows you to delete saved access points and will prevent the OmniLogic from automatically connecting to the deleted wifi network.

Change Password - This selection will allow you to enter a new wifi password. Use this option if you've changed the wifi password on your router/access point.

Network Properties - Network properties will allow you to set a static ip address for the OmniLogic. The OmniLogic will default to a dynamic ip connection and display current network information such as the local/gateway ip addresses. If a static connection is desired, select "Static" and enter the required network information.

Diagnostic - This selection will re-establish a connection to your wireless network and display current network information such as wifi SSID, signal strength, and the local/gateway ip addresses.

Wired - For a wired connection, run an Ethernet cable from the Control Pad to the router (page 23). After selecting "Wired", the system will display the ip address and other network properties. Press the check mark and the OmniLogic will verify the network connection. You can now exit back to the main menu and continue with the Configuration Wizard.

External Antenna - Make this selection when setting up a Hayward HLWLAN. Note that a 2.4GHz connection to the router is required. Once the system is done running through the diagnostics, press the check mark to continue to the next section of the Configuration Wizard.

Not Now - Skip network setup and continue with Configuration Wizard.

Mood Color - To alert the user of warning conditions (no flow, failed sensor, etc.), the OmniLogic can change its screen color. The screen can display yellow or red depending on the severity of the condition.

Simple Mode - Use this selection to enable and disable icons to be displayed while in Simple Mode screen. For more information, refer to the Simple Mode section in the Operation manual.

If Spa Side is selected (requires HLSPASIDE):

Spa Side - Press this button to setup or modify a HLSPASIDE remote control.

Select an Aux button to configure - The 3 Aux buttons on the HLSPASIDE can be configured to run equipment, favorites or themes. In some cases, these buttons may be assigned to default functions. To change functions or assign a new function, select the button that you'd like to configure.

If an Aux button is selected:



Select Function - There are 4 options available.

Equipment - Pressing this button will bring you to a screen that shows all available equipment. Select the desired equipment that you want to assign to the Aux button.

Favorite - Pressing this button will bring you to a screen that shows all available Favorites. These Favorites had to have been defined prior to configuring the Aux buttons. Select the desired Favorite that you want to assign to the Aux button.

Theme - Pressing this button will bring you to a screen that shows all available Themes. These Themes had to have been defined prior to configuring the Aux buttons. Select the desired Theme that you want to assign to the Aux button

Unconfigured - If set to "Unconfigured", the Aux button will have no function.

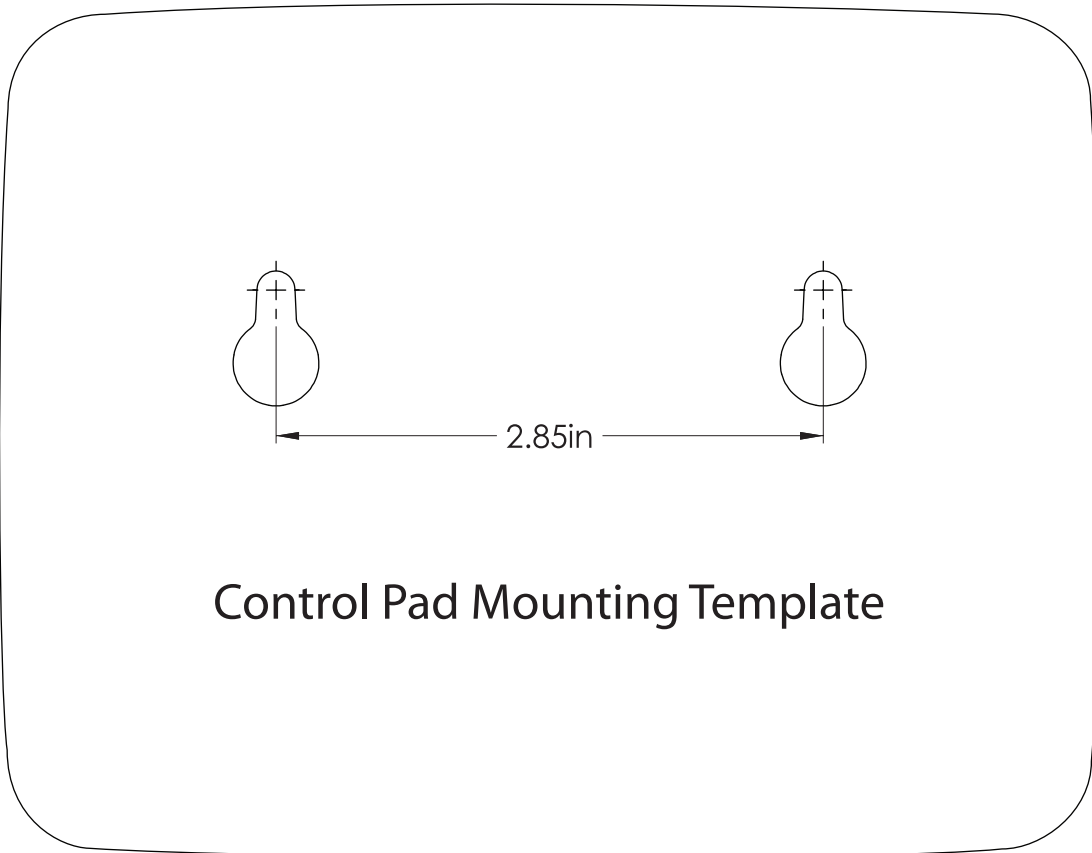

Control Pad Mounting Template



HAYWARD®

LIMITED WARRANTY (effective 03/01/12) Hayward warrants its OmniLogic, OmniHub, Pro Logic, On-Command and E-Command pool automation products as well as its Aqua Rite, Aqua Rite Pro, Aqua Plus and SwimPure chlorination products to be free of defects in materials and workmanship, under normal use and service, for a period of three (3) years. Hayward also warrants its Aqua Trol chlorination products to be free of defects in materials and workmanship, under normal use and service for a period of one (1) year. These warranties are applicable from the initial date of purchase on private residential swimming pools in the US and Canada. Installations of product for use on commercial pools in the US and Canada is covered for a period of one (1) year for defects in materials and workmanship. Hayward warrants all accessories and replacement parts for the above-identified pool automation and chlorination products for a period of one (1) year. Accessories also include remotes, actuators, base stations, temperature sensors, flow switches and chemistry probes. Each of these warranties is not transferable and applies only to the original owner.

Hayward shall not be responsible for cartage, removal, repair or installation labor or any other such costs incurred in obtaining warranty replacements or repair.

Proof of purchase is required for warranty service. If written proof of purchase is not provided, the manufacturing date code will be the sole determinant of the date of installation of the product. To obtain warranty service or repair, please contact the place of purchase or the nearest Hayward authorized warranty service center. For more information on authorized service centers please contact the Hayward Technical Service Support Center (61 Whitecap Road, North Kingstown RI, 02852) or visit the Hayward web site at www.hayward.com.

WARRANTY EXCLUSIONS:

1. Material supplied or workmanship performed by others in process of installation.
2. Damage resulting from improper installation including installation on pools larger than the product rating.
3. Problems resulting from failure to install, operate or maintain the product(s) in accordance with the recommendations contained in the owners manual(s).
4. Problems resulting from failure to maintain pool water chemistry in accordance with the recommendations in the owners manual(s).
5. Problems resulting from tampering, accident, abuse, negligence, unauthorized repairs or alternations, fire, flood, lightning, freezing, external water, degradation of natural stone used in or immediately adjacent to a pool or spa, war or acts of God.
6. Use of a non-genuine Hayward replacement salt chlorination cell on any Hayward automation or chlorination product will void the warranty for that product.

The express limited warranty above constitutes the entire warranty of Hayward Pool Products with respect to its products and is in lieu of all other warranties expressed or implied, including warranties of merchantability or fitness for a particular purpose. In no event shall Hayward Pool products be responsible for any consequential, special or incidental damages of any nature. Some states do not allow a limitation on how long an implied warranty lasts, or the exclusion of incidental or consequential damages, so the above limitation may not apply to you. This warranty gives you specific legal rights, and you may also have other rights, which vary from state to state.



⚠ WARNING - Read and follow all instructions in this owner's manual and on the equipment. Failure to follow instructions can cause severe injury and/or death.

⚠ WARNING – Suction Entrapment Hazard.



Suction in suction outlets and/or suction outlet covers which are, damaged, broken, cracked, missing, or unsecured can cause severe injury and/or death due to the following entrapment hazards:



Hair Entrapment- Hair can become entangled in suction outlet cover.



Limb Entrapment- A limb inserted into an opening of a suction outlet sump or suction outlet cover that is damaged, broken, cracked, missing, or not securely attached can result in a mechanical bind or swelling of the limb.



Body Suction Entrapment- A negative pressure applied to a large portion of the body or limbs can result in an entrapment.

Evisceration/ Disembowelment - A negative pressure applied directly to the intestines through an unprotected suction outlet sump or suction outlet cover which is, damaged, broken, cracked, missing, or unsecured can result in evisceration/ disembowelment.



Mechanical Entrapment- There is potential for jewelry, swimsuit, hair decorations, finger, toe or knuckle to be caught in an opening of a suction outlet cover resulting in mechanical entrapment.

⚠ WARNING - To Reduce the risk of Entrapment Hazards:

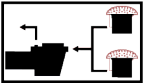

- o When outlets are small enough to be blocked by a person, a minimum of two functioning suction outlets per pump must be installed. Suction outlets in the same plane (i.e. floor or wall), must be installed a minimum of three feet (3') [1 meter] apart, as measured from near point to near point.
- o Dual suction fittings shall be placed in such locations and distances to avoid “dual blockage” by a user.
- o Dual suction fittings shall not be located on seating areas or on the backrest for such seating areas.
- o The maximum system flow rate shall not exceed the flow rating of as listed on Table 1.
- o Never use Pool or Spa if any suction outlet component is damaged, broken, cracked, missing, or not securely attached.
- o Replace damaged, broken, cracked, missing, or not securely attached suction outlet components immediately.
- o In addition two or more suction outlets per pump installed in accordance with latest ASME, APSP Standards and CPSC guidelines, follow all National, State, and Local codes applicable.
- o Installation of a vacuum release or vent system, which relieves entrapping suction, is recommended.

⚠ WARNING – Failure to remove pressure test plugs and/or plugs used in winterization of the pool/spa from the suction outlets can result in an increase potential for suction entrapment as described above.

⚠ WARNING – Failure to keep suction outlet components clear of debris, such as leaves, dirt, hair, paper and other material can result in an increase potential for suction entrapment as described above.

⚠ WARNING – Suction outlet components have a finite life, the cover/grate should be inspected frequently and replaced at least every ten years or if found to be damaged, broken, cracked, missing, or not securely attached.

⚠ CAUTION – Components such as the filtration system, pumps and heater must be positioned so as to prevent their being used as means of access to the pool by young children. To reduce risk of injury, do not permit children to use or climb on this product. Closely supervise children at all times. Components such as the filtration system, pumps, and heaters must be positioned to prevent children from using them as a means of access to the pool.



⚠ WARNING – Hazardous Pressure. Pool and spa water circulation systems operate under hazardous pressure during start up, normal operation, and after pump shut off. Stand clear of circulation system equipment during pump start up. Failure to follow safety and operation instructions could result in violent separation of the pump housing and cover, and/or filter housing and clamp due to pressure in the system, which could cause property damage, severe personal injury, or death. Before servicing pool and spa water circulation system, all system and pump controls must be in off position and filter manual air relief valve must be in open position. Before starting system pump, all system valves must be set in a position to allow system water to return back to the pool. Do not change filter control valve position while system pump is running. Before starting system pump, fully open filter manual air relief valve. Do not close filter manual air relief valve until a steady stream of water (not air or air and water) is discharged.



⚠ WARNING – Separation Hazard. Failure to follow safety and operation instructions could result in violent separation of pump and/or filter components. Strainer cover must be properly secured to pump housing with strainer cover lock ring. Before servicing pool and spa circulation system, filters manual air relief valve must be in open position. Do not operate pool and spa circulation system if a system component is not assembled properly, damaged, or missing. Do not operate pool and spa circulation system unless filter manual air relief valve body is in locked position in filter upper body. **Never operate or test the circulation system at more than 50 PSI.**



⚠ WARNING – Risk of Electric Shock. All electrical wiring **MUST** be in conformance with applicable local codes, regulations, and the National Electric Code (NEC). Hazardous voltage can shock, burn, and cause death or serious property damage. To reduce the risk of electric shock, do **NOT** use an extension cord to connect unit to electric supply. Provide a properly located electrical receptacle. Before working on any electrical equipment, turn off power supply to the equipment. To reduce the risk of electric shock replace damaged wiring immediately. Locate conduit to prevent abuse from lawn mowers, hedge trimmers and other equipment. Do **NOT** ground to a gas supply line.

⚠ WARNING – Risk of Electric Shock Failure to ground all electrical equipment can cause serious or fatal electrical shock hazard. Electrical ground all electrical equipment before connecting to electrical power supply.

⚠ WARNING – Risk of Electric Shock Failure to bond all electrical equipment to pool structure will increase risk for electrocution and could result in injury or death. To reduce the risk of electric shock, see installation instructions and consult a professional electrician on how to bond all electrical equipment. Also, contact a licensed electrician for information on local electrical codes for bonding requirements.

Notes to electrician: Use a solid copper conductor, size 8 or larger. Run a continuous wire from external bonding lug to reinforcing rod or mesh. Connect a No. 8 AWG (8.4 mm²) [No. 6 AWG (13.3 mm²) for Canada] solid copper bonding wire to the pressure wire connector provided on the electrical equipment and to all metal parts of swimming pool, spa, or hot tub, and metal piping (except gas piping), and conduit within 5 ft. (1.5 m) of inside walls of swimming pool, spa, or hot tub.

IMPORTANT - Reference NEC codes for all wiring standards including, but not limited to, grounding, bonding and other general wiring procedures.

⚠ WARNING – Risk of Electric Shock . The electrical equipment must be connected only to a supply circuit that is protected by a ground-fault circuit-interrupter (GFCI). Such a GFCI should be provided by the installer and should be tested on a routine basis. To test the GFCI, push the test button. The GFCI should interrupt power. Push reset button. Power should be restored. If the GFCI fails to operate in this manner, the GFCI is defective. If the GFCI interrupts power to the electrical equipment without the test button being pushed, a ground current is flowing, indicating the possibility of an electrical shock. Do not use this electrical equipment. Disconnect the electrical equipment and have the problem corrected by a qualified service representative before using.

⚠ CAUTION – HAYWARD® pumps are intended for use with permanently-installed pools and may be used with hot tubs and spas if so marked. Do not use with storable pools. A permanently-installed pool is constructed in or on the ground or in a building such that it cannot be readily disassembled for storage. A storable pool is constructed so that it is capable of being readily disassembled for storage and reassembled to its original integrity.

SAVE THESE INSTRUCTIONS

FOR FURTHER INFORMATION OR CONSUMER
TECHNICAL SUPPORT, VISIT OUR WEBSITE AT
www.hayward.com



Hayward is a registered trademark and OmniLogic is a trademark of Hayward Industries, Inc. © 2023 Hayward Industries, Inc.

All other trademarks not owned by Hayward are the property of their respective owners. Hayward is not in any way affiliated with or endorsed by those third parties. For patent information, refer to www.hayward.com/patents.

USE ONLY HAYWARD GENUINE REPLACEMENT PARTS