



OmniHub

Pool Automation Control

Installation Manual



Contents

Before you Begin.....	3
Mounting.....	8
Plumbing.....	10
Wiring.....	11
Startup.....	24
Configuration.....	25
Warranty.....	62

HLOMNIHUB

Hayward Industries
1415 Vantage Park Dr., Suite 400
Charlotte, NC 28203
Phone: (908) 355-7995
www.hayward.com



HAYWARD®

FCC Statement

This device complies with part 15 of the FCC rules. Operation is subject to the following two conditions: (1) This device may not cause harmful interference, and (2) this device must accept any interference received, including interference that may cause undesired operation.

Changes or modifications not expressly approved by Hayward could void the user's authority to operate this equipment.

NOTE: This equipment has been tested and found to comply with the limits for a Class B digital device, pursuant to Part 15 of the FCC Rules. These limits are designed to provide reasonable protection against harmful interference in a residential installation. This equipment generates, uses and can radiate radio frequency energy and, if not installed and used in accordance with the instructions, may cause harmful interference to radio communications. However, there is no guarantee that interference will not occur in a particular installation. If this equipment does cause harmful interference to radio or television reception, which can be determined by turning the equipment off and on, the user is encouraged to try to correct the interference by one or more of the following measures:

- Reorient or relocate the receiving antenna.
- Increase the separation between the equipment and receiver.
- Connect the equipment into an outlet on a circuit different from that to which the receiver is connected.
- Consult the dealer or an experienced radio / TV technician for help.

Industry Canada Statement

This Class B digital apparatus complies with Canadian ICES-003.

Cet appareil numérique de la classe B est conforme à la norme NMB-003 du Canada.

The term "IC" before the certification / registration number only signifies that the Industry Canada technical specifications were met.



Table of Contents

Before you Begin.....	3
Overview.....	4
Mounting	
Wiring Hub.....	8
Controller.....	8
Smart Relay.....	9
Temperature Sensors.....	10
Plumbing.....	10
Electrical Wiring	
High Voltage.....	12
Low Voltage.....	18
System Startup.....	24
Configuration	
Pre-Programmed Configuration.....	27
Typical Configuration.....	28
Advanced Configuration.....	30
Quick Edit.....	49



HAYWARD®

Before you Begin

What's Included

Check that the following components have been included in your package:

- Wiring Hub
- Controller
- Smart Relay
- 2 Temperature Sensors
- 15 ft, 3 conductor (red, black and bare wire) cable for low voltage connection to Wiring Hub from a variable speed pump (VSP) or Heater
- 2 Wiring Whips - 6 ft flexible conduit containing three 12AWG conductors (red, black and green) for filter pump and Smart Relay installation. A length of white 12 AWG conductor is included to replace red for 115 VAC pump and Smart Relay applications
- Input Power Wiring harness and miscellaneous installation hardware

Note that your OmniHub may have been packaged with additional equipment and may contain specific installation information on a separate Quick Start guide.

What's NOT Included

Some of the additional items that you may need to complete an installation include:

Wire

- Wire/conduit for incoming power
- Wire for remote variable speed pump control and other low voltage devices
- Ethernet cable (if not using wifi)

Miscellaneous

- Valve actuator to automate pool functions
- Flow switch for optional pump protection/flow monitoring. A flow switch is required if using Sense and Dispense accessories
- Mounting hardware for mounting Wiring Hub, Controller and Smart Relay
- Cable/cord connectors to provide knockout strain relief
- Wire nut connectors
- USB thumbstick (to update firmware)

Tools Needed

Phillips and flat screwdrivers Wire cutters and strippers Knife to cut conduit
Drill and drill bits (including 3/8") Pliers Level

Accessory Products - Order Separately

HLH485RELAY	Smart Relay used for controlling additional pool equipment
GLX-FLO	Flow Switch used to detect water flow
GVA-24	Valve Actuator
2PC	Temperature Sensor for 3rd input
HLSPASIDE	Wired Spa Remote



HAYWARD®

HL-CHEM	ORP & pH Sensing Kit for monitoring and controlling pool chemistry (requires GLX-FLO flow switch)
HL-CHEM4-ACID	Liquid acid feeder (requires GLX-FLO flow switch)
HL-CHEM4-CHLOR	Liquid chlorine feeder (requires GLX-FLO flow switch)
CL200	Chlorine tablet feeder
AQR940/AQR925	Aqua Rite chlorine generator (requires HLAQRPCB)

Overview

The Hayward OmniHub is a web enabled pool automation control with a convenient touchscreen interface. Automatically and remotely control the pumps, heaters, valve actuators, pool and yard lighting, pool chemistry equipment and more. The OmniHub offers the next generation of technology to manage pool/spa equipment, allowing communication to web connected computers and mobile devices. You can now conveniently monitor your pool/spa and change settings anytime, and from anywhere.

Please read this manual thoroughly before attempting to install, configure or operate this unit. A Quick Start guide may have also been included to offer concise information specific to your equipment. The functions and features described in this manual assume that the OmniHub is using the latest firmware version available from Hayward.

Features

The standard Hayward OmniHub offers the following functionality:

- controls up to 3 variable speed pumps* (VSPs) for pool/spa filtration and water features
- controls up to 3 Smart Relays to turn on/off single speed pumps, pool lights, yard lights, water features, chemical dispensers and more
- controls up to two valve actuators allowing you to manage two bodies of water (both pool and spa) or can be used for water features, cleaners, solar heating, etc.
- controls up to 2 Smart Heaters and one conventional heater (electric heat pump or gas) and optional solar heater (for single body of water applications only)
- inputs for up to 3 temperature sensors or external input devices
- built-in wireless to connect to the home's router/access point (Ethernet port provided for optional wired connection)
- optional flow switch used to protect pool equipment by detecting water flow
- controls an optional Sense and Dispense module (HL-CHEM) which monitors the pool's pH and ORP and can dispense acid for pH control and chlorine for ORP control (requires additional equipment)
- controls an optional Hayward Aqua Rite salt chlorinator. If controlled by the OmniHub, the Aqua Rite must have a HLAQRPCB communication board installed

Optional accessories (page 3) can expand the functionality of the OmniHub. Determine your needs and select the necessary accessories before you begin the installation.

* If a non-Hayward brand VSP or an older non-supported Hayward VSP will be used, the pump can only operate at one speed. The pump must be locally programmed to run 24 hrs/day at a fixed speed and the OmniHub will turn it on and off based on the desired programmed time. Follow instructions to install and function like a single speed pump, using a Smart Relay.



HAYWARD®

Equipment

Wiring Hub

All incoming/outgoing wiring will be connected to the Wiring Hub. The OmniHub can be powered by either 230 VAC or 115 VAC using the selectable input voltage switch. Input power should be constant, not from a timer. If a timer must be used, set the timer to power the Wiring Hub continuously. For convenience, 6 ft Wiring Whips with red, white, black and green colored 12AWG wires are included with the OmniHub.

The remaining connections to the Wiring Hub, including the Controller, are all low voltage. Depending on your installation, these connections could be to a variable speed pump, a heater, Smart Relays, temperature sensors, actuator and a flow switch.

Controller

The Controller is weather resistant and comes with a 15 ft cord. Its resistive touch screen with flip down cover is designed to function year round directly in the elements. Because it plugs into the Wiring Hub, it should be mounted close by, but in a location that is convenient for the user to periodically view and change pool/spa settings. Lastly, the Controller contains the Wifi radio and its location should be considered if planning to use a wireless connection to the home router or access point. A wireless mobile device (phone, tablet, etc.) could be used to test the signal strength at the intended mounting location. The Controller features a USB connector for firmware updates and an Ethernet connector for an optional direct wire connection to your router (if wifi won't be used).

Smart Relay

Smart Relays have a 15 ft communication cable that connects to the Wiring Hub and are used to control high voltage pool equipment like lights, water features, pumps and more. 115 VAC or 230 VAC power to the intended load must be supplied separately and run through the Smart Relay. Smart Relays are rated for up to 20 amps at 230 volts.

Temperature Sensors

Depending on your installation, up to 3 temperature sensors may be used. The OmniHub requires a water temperature sensor for heater operation. If freeze protection is desired, an air temperature sensor is also required. For solar heating systems, a solar sensor is necessary. Even if your installation doesn't require the use of temperature sensors, installing water and air sensors provides a convenience to the user, especially during remote use.

Flow Switch (not included)

An optional flow switch can be used to detect leaks or clogs in the pool/spa plumbing. A flow switch is required if using chemistry Sense and Dispense accessories.

Overview

Before attempting to install the OmniHub, familiarize yourself with the installation steps on the following pages. Also refer to the sample overview diagrams on page 6. Diagram 1 shows wiring to a single speed pump and a conventional gas heater. Single speed (and two speed) pumps are controlled by Smart Relays. In this example the high voltage for the conventional gas heater is wired in parallel with the Wiring Hub. A Wiring Whip is used for this connection. A separate remote control connection is made from the Wiring Hub to the heater.



HAYWARD®

Diagram 2 shows wiring to a supported VSP and electric heat pump heater. Variable speed pumps must have constant input power and require a communication connection to the Wiring Hub. In this example, the high voltage VSP is wired in parallel with the Wiring Hub. Heat pumps, which require a separate circuit from the electrical panel, only have a remote control connection to the Wiring Hub.

Diagram 1

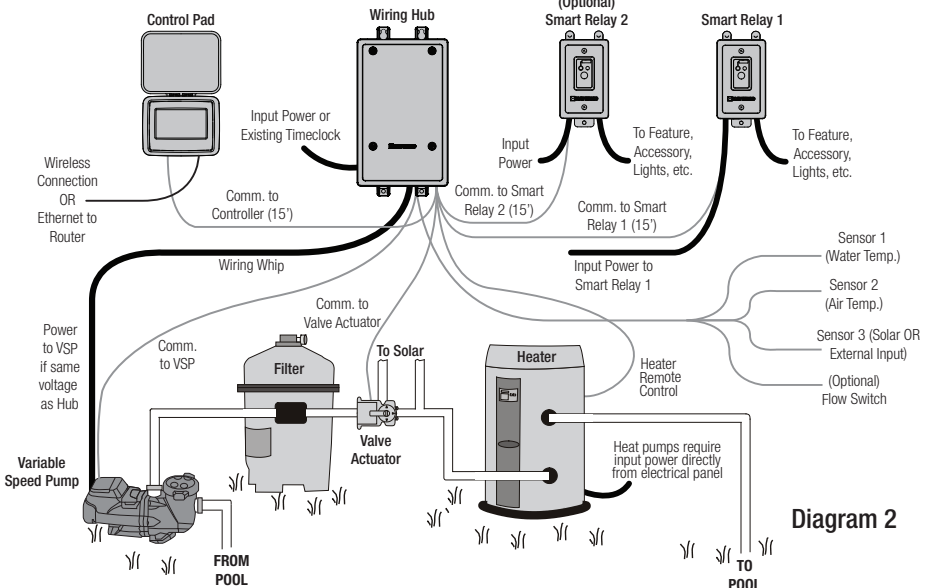
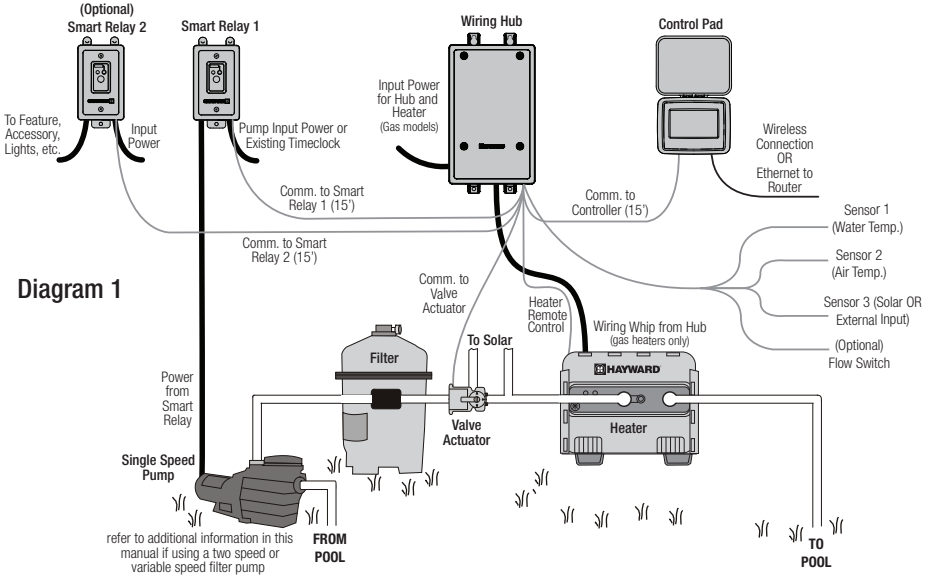

Diagram 2



HAYWARD®

These Overview diagrams are offered as a guide and it's likely that your installation will require you to use some combination of two configurations. Refer to the following pages for specific wiring information and note the required voltage for each piece of equipment. Keep in mind that the Wiring Hub can be powered by either 115 VAC or 230 VAC when wiring equipment in parallel. Lastly, be aware of each circuit breaker's rating and don't exceed their rated load.

Installation

Installation Steps

DANGER of Death, Injury or Property Damage if procedure not followed. Power wiring must be shut off before attempting to install the OmniHub.

The OmniHub is designed to be mounted outdoors at the pool pad. Both the Wiring Hub and the Controller are water resistant and can be left out for the winter. Details on each installation step are shown below:

1. Mounting the equipment (page 8)
 - Wiring Hub
 - Controller
 - Smart Relay
 - Temperature sensors
 - Valve actuators (if applicable)
2. Plumbing (page 10)
 - General Pool Equipment
 - Flow Switch
3. Electrical Wiring (page 11)
 - Wiring Hub power
 - Grounding
 - Wiring (Pool Pump Communication, Heater, Smart Relays, Temperature Sensors, Flow Switch, etc.)
5. System Startup and Firmware Upgrade (page 24)

Your OmniHub may have been packaged with additional equipment and may contain specific installation information on a separate Quick Start guide. If so, refer to both this document and your Quick Start guide for installation instructions.

If your OmniHub was packaged with a 230 VAC pump and you are using actuators, you may be required to use 230 VAC input power. If so, a product label located on the mainboard will instruct the installer of this requirement.



HAYWARD®

Mounting the Equipment

Wiring Hub

The Wiring Hub is contained in a raintight enclosure that is suitable for outdoor mounting. It must be mounted a minimum of 6 ft (2 meters) horizontal distance from the pool/spa (or more, if local codes require). The Wiring Hub is designed to mount vertically with the knockouts facing downward. Do not mount the Wiring Hub inside a panel or tightly enclosed area.

When selecting a location, note that the standard cables supplied with the optional flow switch, temperature sensors, and actuators are all 15 ft (5m) long. Additional low voltage connections will have to be made to the heater and VSP, if used. 230 VAC or 115 VAC input power must also be run to the Wiring Hub. Try to mount the Wiring Hub in a location where incoming/outgoing wiring will be easily accessible.

Mount the Wiring Hub on a wall or flat surface. Select mounting hardware that is appropriate for the mounting surface and material. The Wiring Hub has two keyhole type mounting tabs on the top and bottom of the enclosure requiring a total of 4 fasteners.

Controller

The Controller comes with a 15 ft cord and plugs into the Wiring Hub. It should be mounted in a location that is convenient for the user to view and change pool/spa settings. When considering the mounting location, make sure there is enough clearance above the enclosure so that the flip door will be able to be opened fully. Also be sure to allow enough clearance below the Controller to access the USB and Ethernet connectors. For best viewing results, position the Controller where it won't be subjected to direct sunlight.

A mounting template is provided on page 61. The Controller has two keyhole cutouts on the back of its enclosure. To mount, screw two fasteners into the mounting surface at the desired location as shown in the diagram on page 9. Tighten until the bottom of the screw heads are 1/8" off the mounting surface. Position the Controller cutouts over the screw and slide the unit downward. You may have to tighten or loosen the screws slightly to fully engage the screw heads to get a snug fit.

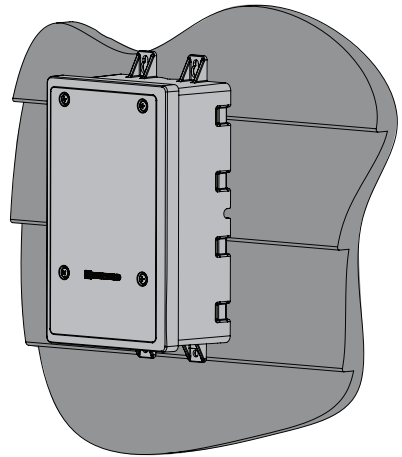



HAYWARD®

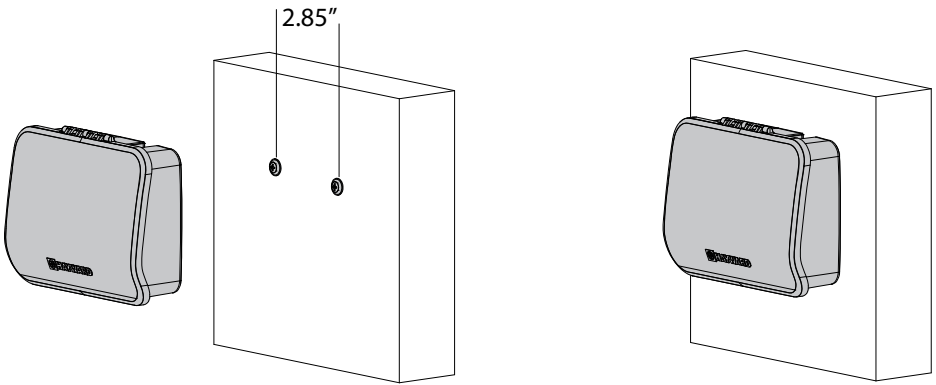

Smart Relay

The Smart Relay is packaged with a single gang electrical box but can also be used with any existing comparable standard electrical box with a minimum volume of 16.2 in³. If using 115 VAC, make sure that there is a Neutral line inside the box before installation. If not, you must run a separate Neutral wire to power the Smart Relay. This is not a concern if using 230 VAC. Note that conduit and connections to the included plastic box must be non-metallic.

Find a location within 15 ft of the Wiring Hub with convenient access to the pool equipment that you intend to control with the Smart Relay. Three threaded 1/2" NPT knockouts are provided for high voltage power coming into the relay and for power out to the pool equipment. A Wiring Whip is included to aid installation.

The Smart Relay has a manual On/Off button that can be used if communication is lost with the Wiring Hub. Although this button is not functional during normal operation, mount the Smart Relay in an accessible location to use this feature in case of communication loss. Refer to page 17 for Smart Relay LED information.

Mount the Smart Relay to a wall or other flat surface using the mounting holes which are designed to accommodate #8 screws.

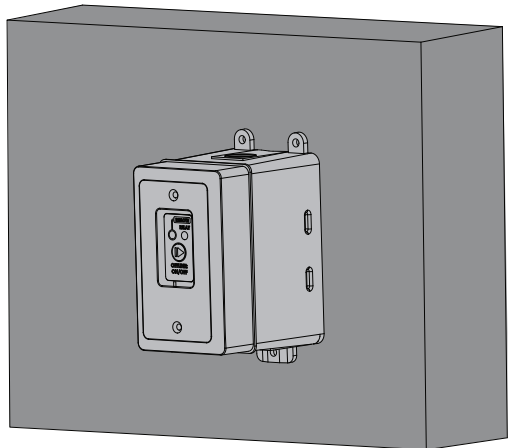



HAYWARD®

Temperature Sensors

Water Sensor

This sensor is used to measure the pool/spa temperature and is installed in the filtration plumbing after the filter but before either the solar or conventionally fueled heaters.

1. Drill a 3/8" (10mm) diameter hole in the PVC piping and remove all chips and burrs.
2. Insert sensor until O-ring collar sits flush on the hole.
3. Position hose clamp over the sensor and gently tighten until O-ring makes an adequate seal. Do not overtighten.

Air Sensor

Mount the air sensor outdoors. **IMPORTANT:** The air sensor must not be mounted in direct sunlight.

Solar Sensor

For solar applications, mount the sensor near the solar collector array so that it is exposed to the same sunlight as the collectors. Use additional cable (20 AWG) if necessary.

Optional Valve Actuators

For installation, refer to the mounting instructions included with the Hayward GVA-24 actuator or equivalent. After configuring and first operating the valve, note that the internal cams in the actuator may have to be adjusted depending on the way the actuator is mounted on the valve and the desired valve action.

Plumbing

Flow Switch

A Hayward GLX-FLO flow switch (sold separately) is required if an HL-CHEM ORP & pH Sensing Kit will be used. If no chemistry equipment is installed, the GLX-FLO is optional and can be used to detect leaks or clogs in your pool's plumbing system. If using the GLX-FLO, it must be plumbed in line with any chemistry sensing/dispensing equipment at the very end of the return plumbing. This will ensure that the OmniHub will detect a leak if it occurs anywhere at the pool pad. Understand that if a leak occurs after the flow switch (downstream), the OmniHub will not sense a no-flow condition.

IMPORTANT: There must be at least a 12" (30cm) straight pipe run before (upstream) the flow switch.

IMPORTANT: To ensure proper operation, verify that the arrow on the flow switch points in the direction of water flow.

Filter Pump

If the OmniHub has been packaged with a filter pump, refer to the included pump manual for plumbing information.



HAYWARD®

Electrical Wiring

The Wiring Hub requires both high and low voltage connections. Always:

- Ensure that Power is disconnected prior to performing any wiring
- Follow all local and NEC (CEC if applicable) codes
- Use copper conductors only

A dedicated channel on the right side of the Wiring Hub has been provided for all low voltage wiring. All low voltage wires should run through this channel to exit the Wiring Hub. A weather resistant gasket is provided (see page 24) to seal this exit.

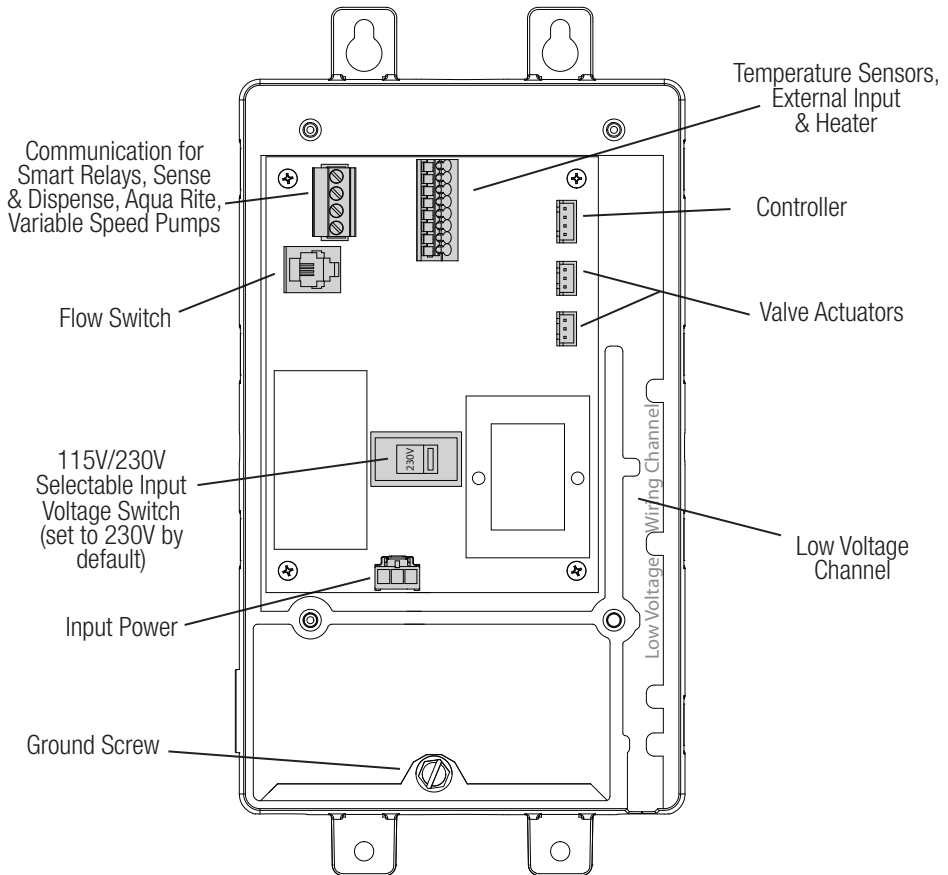



HAYWARD®

High Voltage Wiring

Hub Input Power

The Hub requires a constant 115 VAC or 230 VAC input power to operate. A wiring harness is included and will plug into the input power connector shown on page 11. The 115V/230V input voltage switch must be set to the correct position. Refer to the diagrams below.

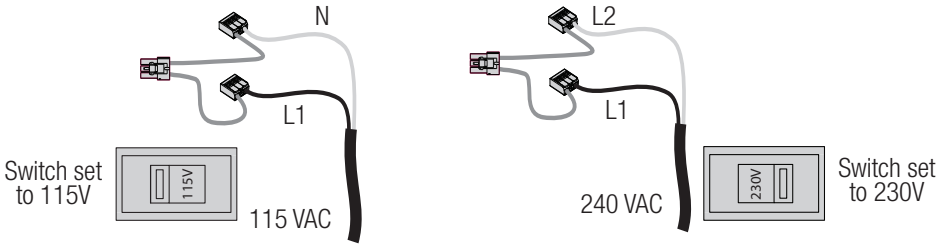

Wiring Filter Pump Input Power

Note that Hayward supported variable speed pumps (VSPs) will connect to the OmniHub differently than single speed (or two-speed) filter pumps. Single and two speed pumps are wired to Smart Relays while VSPs are wired to a constant power source. The following information will show how to wire both types. Refer to your filter pump's manual for the location of the input wiring terminals as well as other related high voltage wiring information.

Powering Hub and VSP with Same Voltage

Variable speed filter pumps require constant power and are turned on and off through low voltage communication wiring from the OmniHub. Because the OmniHub must also be powered continuously, it may be most convenient to wire the VSP and OmniHub in parallel, on the same circuit. If this is the case, they must both be powered by the same voltage. An example of this is shown below.

As shown in Diagram 2 on page 6 and below, power can come from an existing timer, switch or an electrical panel. Because both units need to be powered constantly, if power comes from a switch or timeclock, set it to run continuously.

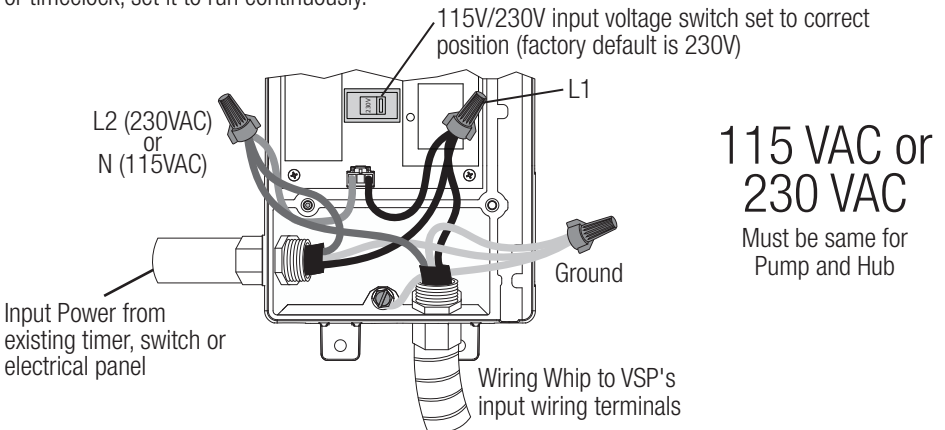



HAYWARD®

Powering Hub and VSP with Different Voltage

Wire the Hub and VSP separately if using different voltages for both. If the new pump requires a different voltage than the old, run a separate source from the electrical panel. The Hub, which can be powered by either 115 VAC or 230 VAC, can be powered by the existing timeclock or switch. Both units need power constantly so if there is a switch or timeclock in the system, it must be set to run continuously. The example below shows the Hub powered by 115 VAC and the pump powered by 230 VAC.

115 VAC to Hub

Connect 115 VAC from the panel, timeclock, outlet or switch. Make sure Omni-Hub is powered constantly.

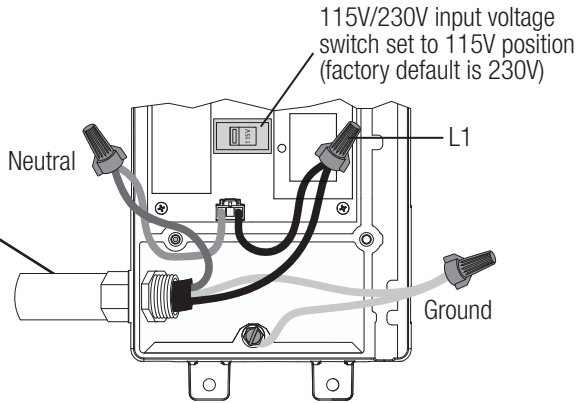

Electrical Panel

Run separate 230 VAC constant source to the new VSP

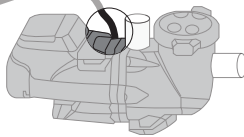

230 VAC to VSP

Powering Hub and Single Speed Pump with Same Voltage

Single speed pumps require the use of Smart Relay(s). High voltage connections are made directly to Smart Relays which are turned on and off through a low voltage communication connection to the OmniHub. Like the OmniHub, Smart Relays can be powered by either 115 VAC or 230 VAC.



HAYWARD®

The example below shows a typical retrofit of the OmniHub into a system with an existing 115 VAC filter pump. In this case, switched or timed input power to the pump is disconnected and distributed to the input sides of both the OmniHub and a Smart Relay. Because the OmniHub and Smart Relays require constant power, an existing timeclock or switch must be set to power both constantly. The 115 VAC pump is then wired to the output side of the Smart Relay.

Note that this connection method will work for 230 VAC, using the 230 VAC connections on the Smart Relay and the input voltage selection switch set to the 230 VAC position.

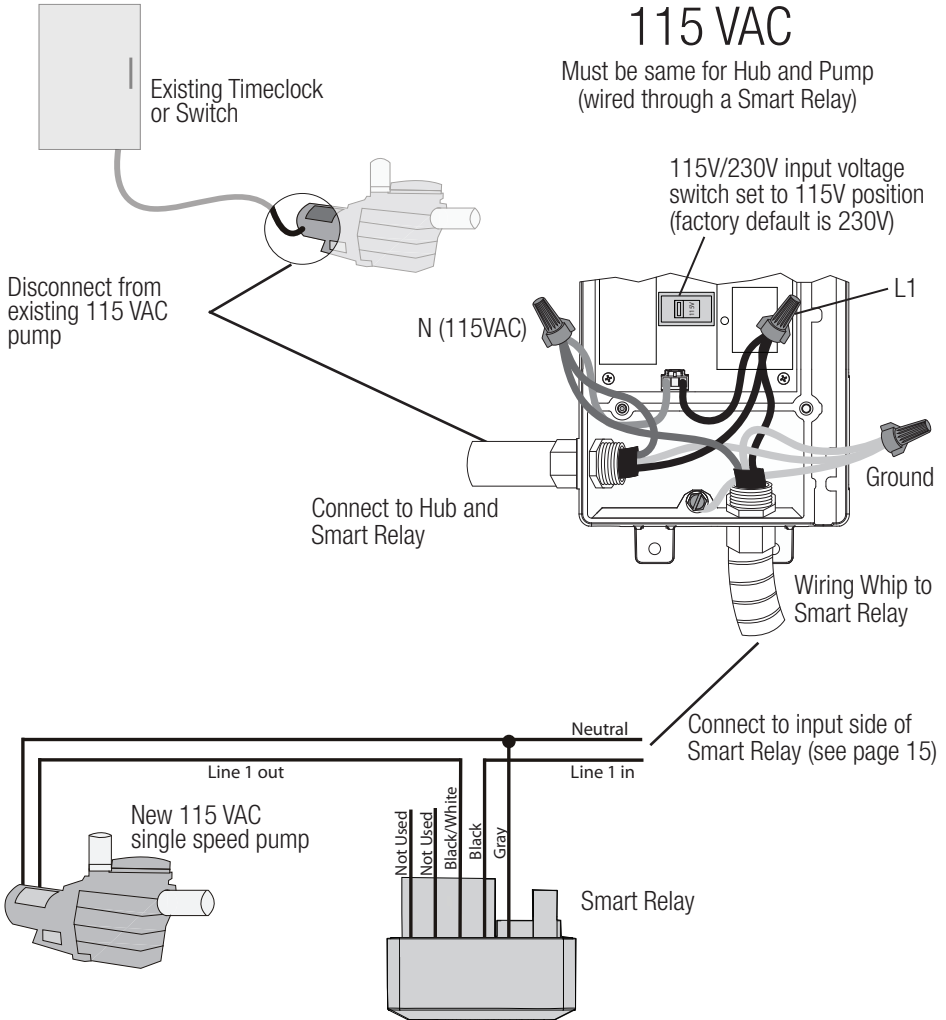

Powering Hub and a Single Speed Pump with Different Voltage

Example: The diagrams below show the Wiring Hub powered by 115 VAC directly from the electrical panel. The existing 230 VAC wiring at the pump is disconnected and used to power the input side of the Smart Relay. The output side of the Smart Relay is then wired to the pump.

115 VAC to Hub

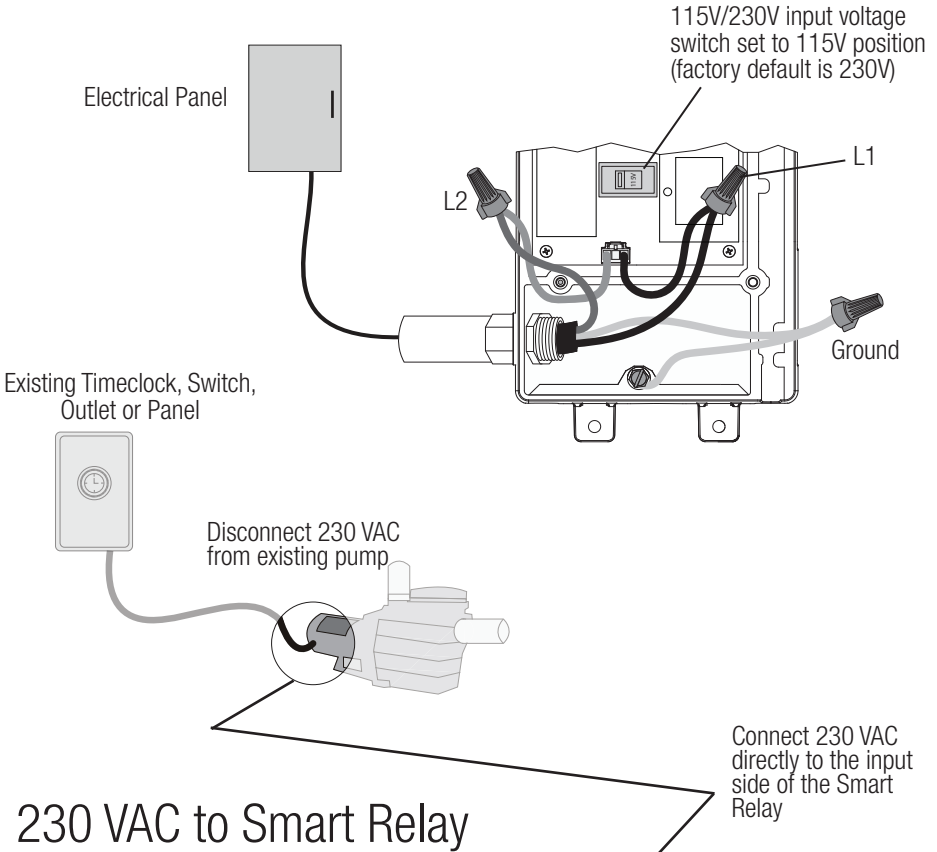

230 VAC to Smart Relay

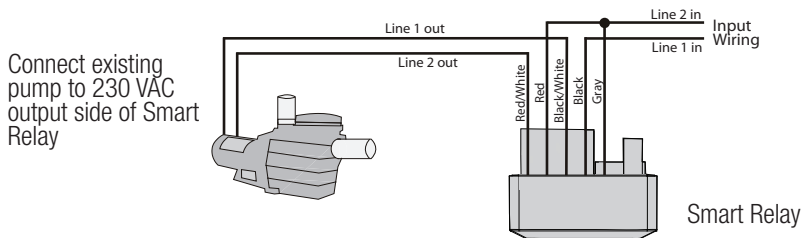



Grounding

Connect a ground wire from the primary electrical panel to the Wiring Hub's ground connection as shown in the previous diagrams. Also ground each piece of high voltage equipment that is connected through the Wiring Hub or Smart Relay.

Smart Relay Load Wiring

A Smart Relay can be used to control either 115 or 230 VAC pool equipment. Previous diagrams showed a Smart Relay connected filter pumps but other high voltage equipment like accessory water feature pumps, lights, cleaners, transformers, etc. can be controlled as well.

Smart Relays can be installed into an existing electrical box with a minimum volume of 16.2 in³ or with the box supplied with the OmniHub. Use the included Wiring Whip if the supplied electrical box will be mounted within 6 ft of the power source. Red, black and green conductors are included for 230 VAC wiring. A white conductor is supplied if using 115 VAC input power. Use the included wire nuts for wiring connections. Use proper threaded strain relief fittings when attaching conduit to knockouts. Be sure to set the 115V/230V input voltage switch on the Hub PCB to the appropriate position. After wiring is complete, carefully insert the cover with connections into the box and secure.

For accessory equipment, refer to the table and diagrams below.

115 VAC	Smart Relay Wire Colors	230 VAC
Line in	Black	Line 1 in
Load out	Black/White	Load 1 out
Neutral	Gray	Connect Gray & Red to Line 2 in
No Connection	Red	
No Connection	Red/White	Load 2 out

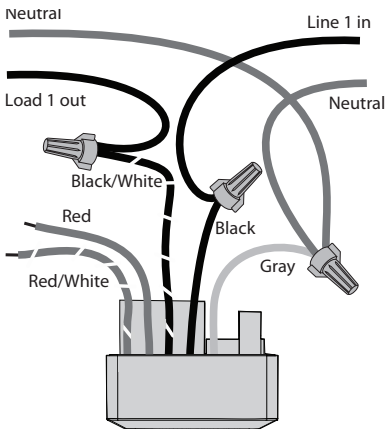

115 VAC

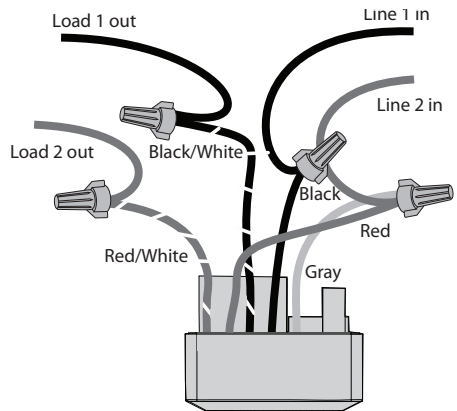

230 VAC



Powering a 230 VAC Two Speed Pump

A 230 VAC two speed pump requires the use of two Smart Relays. Refer to the diagram below.

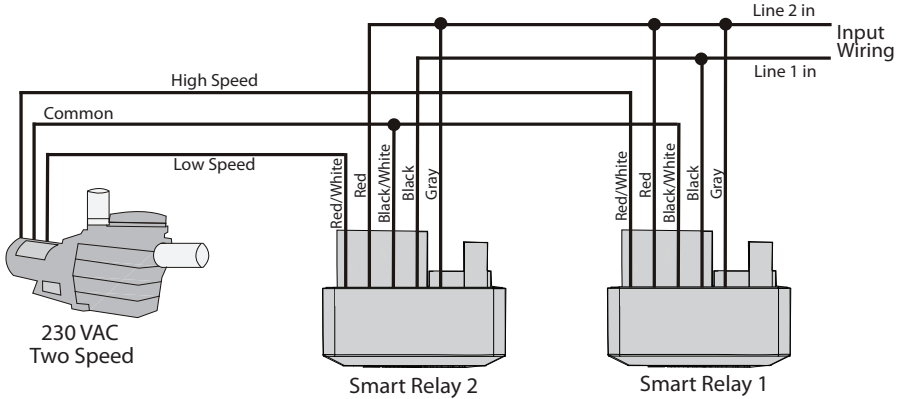

Smart Relay LEDs and On/Off button

Although the Smart Relay will be automatically controlled by the Hub, it does feature a manual On/Off button as well as two indicator LEDs. If communication has been interrupted or lost to the Wiring Hub, the Smart Relay's On/Off button will allow you to toggle back and forth between power states. This button will not be functional during normal operation.

Refer to the table below when viewing the Smart Relay's indicator LEDs. Note that when the "Relay On" LED is OFF, the relay is in an OFF state and there is no power going out to the load. When Green, the relay is energized and the load receives power.

Remote LED	Relay On LED	Indication
Off	Off	No power or firmware failure
Red On for 1 sec, Off for 6 sec	Off or Green	There is no communication with the Wiring Hub - the relay can be manually controlled using the On/Off button
Green On	Off or Green	There is communication with the Wiring Hub - this indicates normal operation and On/Off button is disabled
Green 3 fast blinks	Off or Green	User attempted to use the On/Off button manually while the Smart Relay is being automatically controlled by Wiring Hub (not allowed)
Blinking	Blinking	Firmware upgrade in progress

Universal ColorLogic Lights (UCL)

Transformers powering multiple UCLs must be wired to the same Smart Relay if synchronization or Omni Direct mode is desired. Omni Direct mode is only supported by Universal ColorLogic lights built after June 2018.



Low Voltage Wiring

NOTE: There is a low voltage channel on the right side of the Wiring Hub's enclosure labeled on page 11. All low voltage wiring that exits the Wiring Hub must run through this channel. The included foam gasket (page 24) should be used to seal the channels's exit after wiring is complete. Do not run low voltage wiring through a knockout or with any high voltage wiring.

Hayward Variable Speed Pump (VSP) Wiring

If using a Hayward TriStar 950, TriStar 900, Super Pump 700 or MaxFlo 500, the pump can be fully controlled (schedules and speeds) by the OmniHub. Refer to the VSP Communication Wiring table on page 19 as well as the diagrams below for low voltage communication wiring instructions. Up to three VSPs can be controlled by the OmniHub.

TriStar VS 900, Super Pump VS 700, MaxFlo VS 500

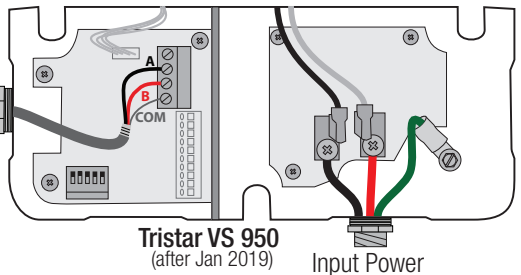
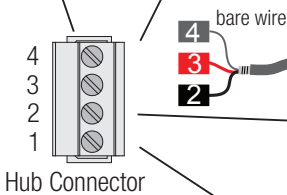
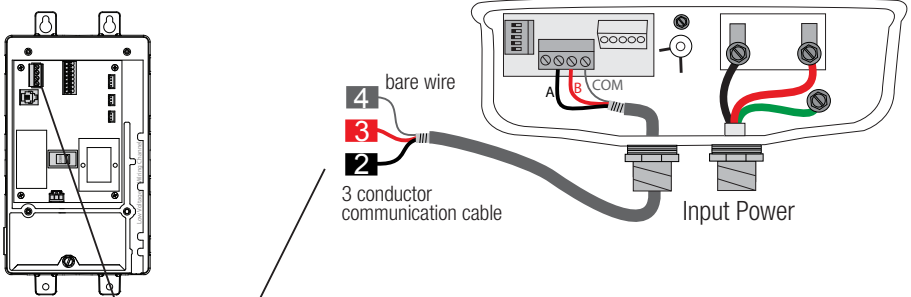

For pump models with dip switches, set all switches to OFF position (as shown). Remove the display cable. Use the spare connector taped to the display cable for the communication cable connection.

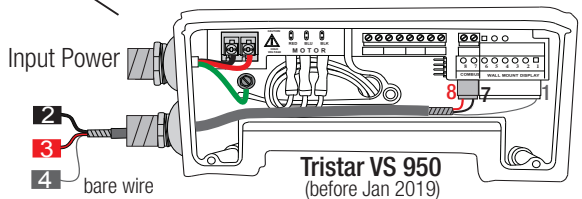



VSP Communication Wiring Table

Pump Model	Hub Conn.	Pump Conn.
TriStar® VS 950 Omni (before Jan 2019)	2	7
	3	8
	4	1
*TriStar® VS 950 Omni (after Jan 2019)	2	A
*TriStar® VS 900 Omni	3	B
*Super Pump® VS 700 Omni	4	COM
*MaxFlo VS 500 Omni		

*Disconnect onboard display and set all dipswitches to OFF position.

Smart Relays

Like VSPs, Smart Relays rely on communication from the Wiring Hub. Their 4 conductor cable is wired to the same connector as a VSP. Wire the cable as shown below. Up to three Smart Relays can be controlled by the OmniHub.

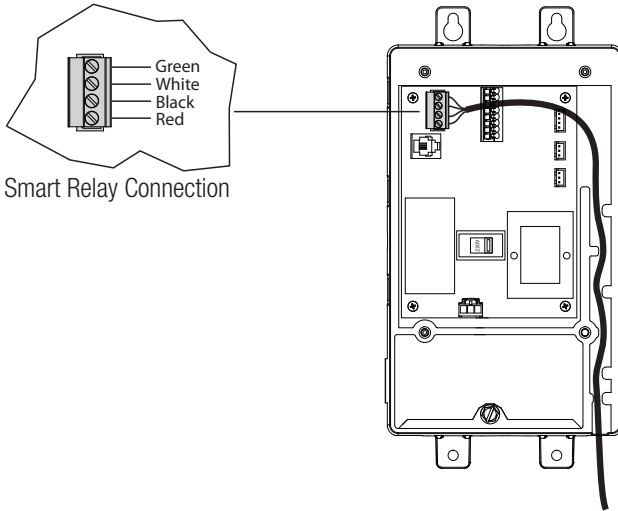

Valve Actuators

The OmniHub can control up to two valve actuators which allow automated control of pool/spa, water features, cleaners or solar heating and is compatible with standard valve actuators manufactured by Hayward, Pentair/Compool, and Jandy. Actuators have 15 ft cables that are terminated with connectors that plug directly into the Hub as shown on page 11.

Temperature Sensors

The Wiring Hub utilizes 10K ohm thermistor type sensors with 15 ft cable. If a longer cable is required, contact the Hayward service dept. (908-355-7995) for information on suitable cable types and splices.



Temperature sensors are wired to the 8 position connector shown on page 11 and on the following page. To unlock, push on the corresponding lever with a small tool as shown. When pushed, the connector will be open and able to receive the wire lead. For best results, strip back leads 1/8" before inserting. After the wire is fully inserted, release the lever and the wire will lock in place.

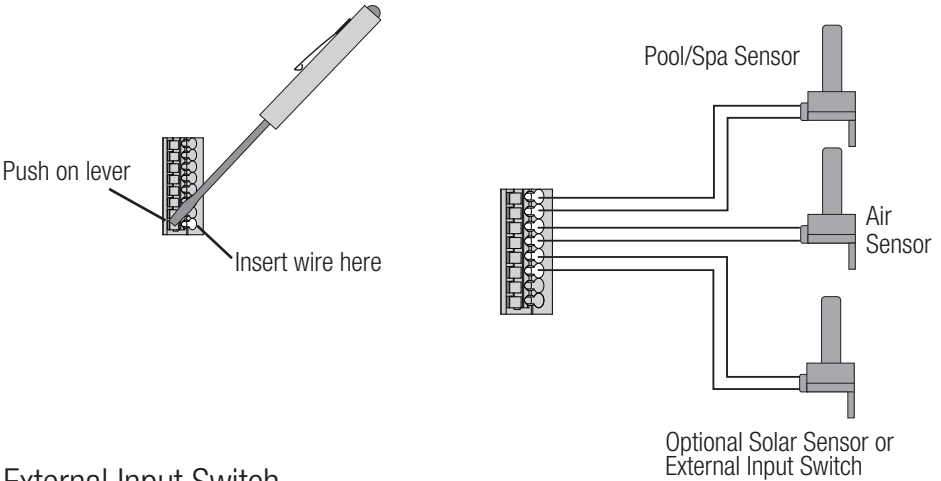

External Input Switch

If solar heating won't be used, a SPST external switch/device can be connected to this input. This normally open or normally closed on/off external device provides a means to turn the filter pump or other pool equipment on or off when certain conditions exist. Connect the external switch as shown below. After properly configuring the OmniHub (see Configuration Wizard), the filter pump and/or desired pool equipment will be forced on or off when the external device is activated.

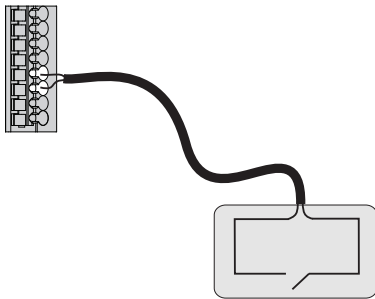

SPST External Switch
Either Normally Open or Normally Closed

Controller

The Controller has a 15 ft cable with a connector that plugs directly into the Wiring Hub as shown on page 11. There are rubber plugs covering USB port and Ethernet port on the bottom of the Controller enclosure. The Ethernet port is available if a wired connection to the access point is desired over the built-in wifi. The USB port is used for firmware upgrades.

Optional GLX-FLO Flow Switch

The 15 ft flow switch cable plugs into the flow switch connector shown on page 11. Ensure that the connector catch “snaps” into place in order to provide a reliable connection.

Optional Sense and Dispense

The OmniHub can be used with the Hayward HL-CHEM Sense and Dispense Kit. Using the HL-CHEM, the OmniHub will continuously monitor the pool's pH/ORP levels and automatically dispense chemicals (using a Hayward Aqua Rite salt chlorinator or a liquid/tablet feeder) to correct pH or add chlorine when needed. The HL-CHEM connects in the same manner as a Smart Relay using the on-board connector shown on page 11. High voltage chemical dispensing pumps are connected directly to a Smart Relay. Refer to the HL-CHEM manual for installation instructions.

Optional Aqua Rite Salt Chlorination

The OmniHub can control an Aqua Rite chlorinator and generate chlorine based on the pool's ORP level (using HL-CHEM) or as a percentage of run time, producing small amounts periodically throughout the day. The standard Aqua Rite requires an HLAQRPCB communication board (sold separately) and connects to the OmniHub in the same manner as a Smart Relay. The HLAQR940 bundle (OmniHub + AQR940 Aqua Rite) contains the HLAQRPCB kit which can be used with minor assembly (see instructions included with the bundle).

Heaters

The manual supplied with your heater includes specific wiring instructions for connecting to an external control, usually identified as “2-wire” remote control. Use the supplied 15 ft cable to connect the heater to the 8 position connector located on the Wiring Hub. Wiring for current Hayward heater models is shown below.

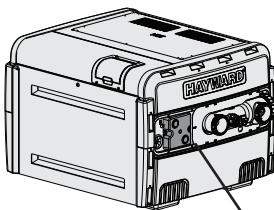
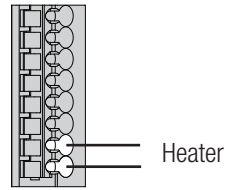

Remove Cover to Access Junction Box

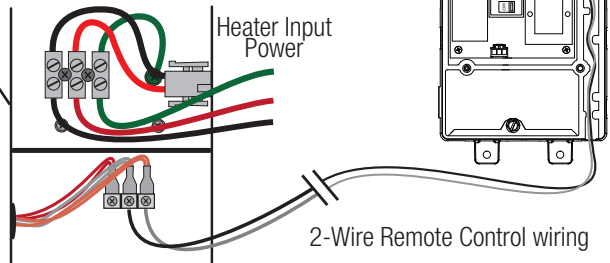



HAYWARD®

Hayward H-Series Gas Heaters Hayward HeatPro Electric Heat Pump Heaters

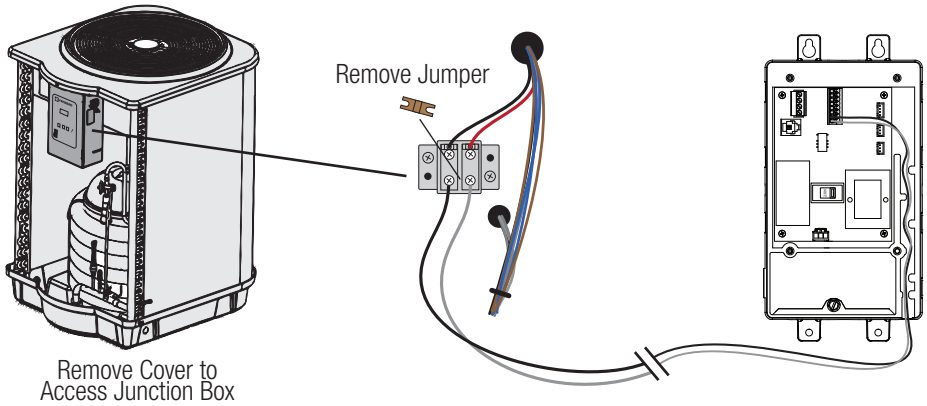

Smart Heater Control

Smart Heaters are programmed with a Hayward Unique Address (HUA) which allows it to be fully controlled by a Hayward Omni pool automation control. Similar to other Smart Devices such as select Hayward variable speed pumps, you will be able to remotely create schedules and setpoints for both heating and cooling while displaying real time heater status and diagnostics for the Smart Heater. The Omni family of products provide a 3 wire cable connection used to communicate with the Smart Heater and requires firmware revision R4.3.0 or later.

Disconnect power to both the Smart Heater and the Omni control before removing their panels. Use a proper outdoor rated 3 conductor 22 AWG cable (20 AWG for runs over 30 ft) for the connection from the Omni control to the Smart Heater. Route the cable through appropriate knockouts making sure they are not shared with high voltage wiring. Refer to the diagram on the following page showing a Hayward OmniLogic control wired to the Smart Heater. Note that the position of each colored conductor is the same at both ends of the communication cable. Refer to your Smart Heater manual for specific wiring instructions. After the communication cable is fastened and secure, refasten the panels.



HAYWARD®

Connection at OmniHub

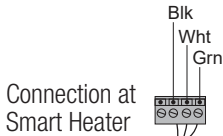
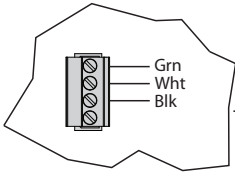

Connection at Smart Heater

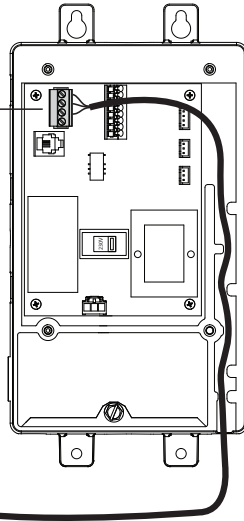

Home Router

Connection to the web is optional. If web enabled devices such as PCs, laptops, tablets or phones will be used to access the OmniHub, an Ethernet or wireless connection must be made to the home router. For wireless connections, a 2.4GHz connection to the router is required. For Ethernet connections, use outdoor rated Cat5e or Cat6 Ethernet cable. Connect one end to the Controller and the other to an available LAN port (not WAN) on the home router or access point. Refer to the diagram below.

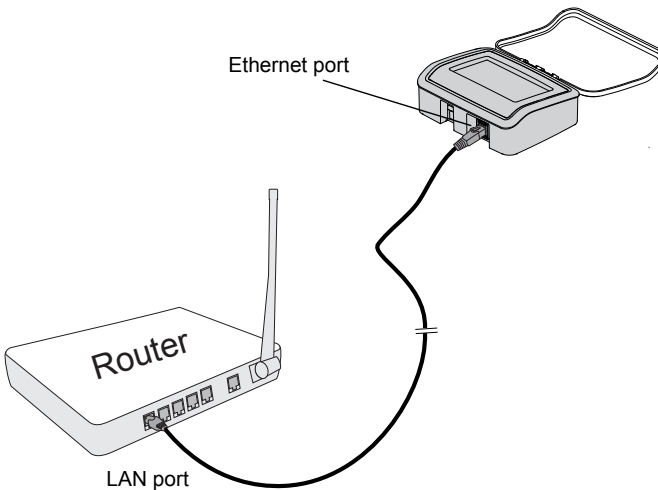

Final Steps

With the wiring complete, find the Wiring Hub's cover. The inside of the cover is made of foam and contains precut removable gaskets (shown below) that can be used to seal the low voltage exit. Remove a gasket and wrap it around the low voltage wiring at the exit of the Wiring Hub. Work the gasket into the exit slot until it is fully sealed then fasten the cover to the Wiring Hub.

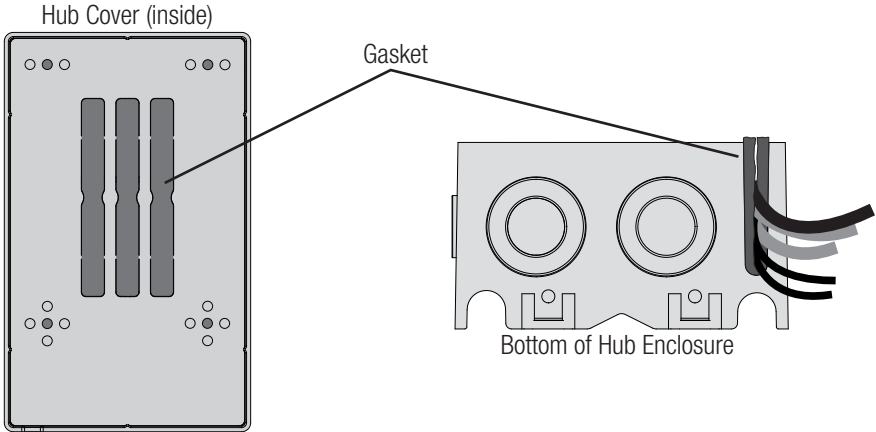

System Startup

After confirming that all wiring has been performed according to NEC and local codes and that the Wiring Hub is properly grounded, apply power to the OmniHub. The OmniHub will take about 30 seconds to fully start.

Firmware Upgrade

The OmniHub's firmware is the basic operating system that runs the system. The OmniHub was shipped with the version of firmware that was available at the time of release. There may be a newer version available and if so, we encourage you to upgrade. Also, if you have experienced problems, Hayward Technical Support may advise you to upgrade your OmniHub's firmware. To upgrade the OmniHub firmware, refer to the procedure shown in the OmniHub Operation Manual. Upgrading firmware can be performed before or after Configuration but should be done before the OmniHub begins operation.



Configuration

Initial Configuration

Because this is the first time that the OmniHub has been powered on, you will be brought directly to the initial configuration screen shown below. Note that the OmniHub Controller uses a resistive touch screen that is appropriate for a pool environment. It requires a deliberate push when selecting a button. At the initial configuration screen, touch the “en” button to select a language (the default language is English) and then touch “OK” to begin configuration. After pressing “OK” you will be prompted to select the type of configuration wizard that you would like to use as shown below. See the descriptions in the “About the Configuration Wizard” section for information about each type of configuration wizard so that you can choose the right one to fit your needs and make configuration as simple as possible.

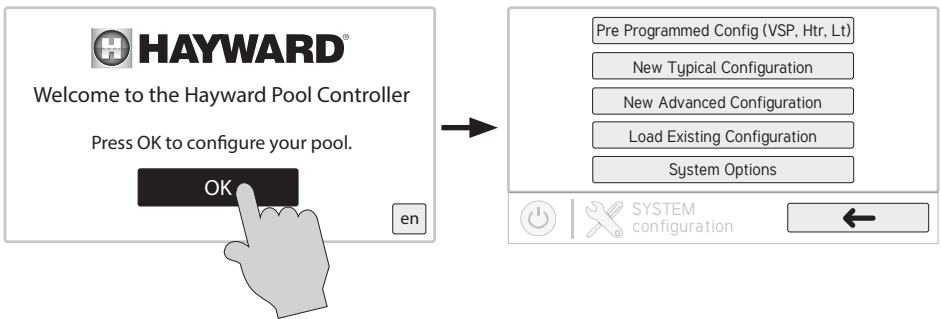

About the Configuration Wizard

The OmniHub Configuration Wizard will ask you general questions relating to your pool or spa and specific questions about connected pool equipment. Because this process may take some time, do not begin to configure the OmniHub unless you can dedicate at least 15 minutes or more. Configuring the OmniHub requires knowledge of all of the connected pool equipment.

If you are asked a question and don't know the answer, in many cases you'll be able to skip the question and proceed. In some cases the Configuration Wizard will require an answer. Answer the question to the best of your ability and take note as you'll be able to go back into the Configuration Wizard at a later time to make changes.

There are four different options for configuring the OmniHub: Pre-Programmed configuration, Typical configuration, Advanced configuration, and Load Existing configuration. The differences between these Configuration Wizards are described below.

Pre Programmed Configuration

This Configuration Wizard is the most basic and takes the least amount of time to complete. This option should be used if your system has only one variable speed pump, one heater (gas/heat pump), and one Smart Relay for a light, an air sensor, and a water sensor.



HAYWARD®

The Pre-Programmed Configuration option also comes with the following pre-programmed schedules which can be changed:

1. Filter Pump - 8:00 AM to 8:00 PM / All Week / Medium Speed
2. Light - 7:00 PM to 11:00 PM / All Week

See page 27 for a full Pre-Programmed Configuration Wizard.

Typical Configuration

Use this Configuration Wizard if you have at least one variable speed pump and up to 2 Smart Relays in your system. See page 28 for a full Typical Configuration Wizard.

Advanced Configuration







This Configuration Wizard is the most detailed and takes the most amount of time to complete. This option can be used with VSPs, single speed or two speed filter and accessory pumps. Also use this option if you are managing two bodies of water, using valves, multiple heaters (gas/heat pump + solar), and/or interlocks. See page 30 for a full Advanced Configuration Wizard.

Load Existing Configuration

This option should be used if you already have a pre-made configuration loaded onto a thumb drive that is ready to be uploaded to the OmniHub.

Navigation

The Configuration Wizard has been designed to be intuitive allowing most users the ability to navigate with little instruction. A list of commonly used buttons is shown below:

-  **Done** - Touch this button to complete your selection.
-  **Cancel** - Touch this button to cancel your selection.
-  **Advance** - Touch this button to advance to the next screen.
-  **Back** - Touch this button to return to the previous screen.
-  **Add** - Touch this button to add an item
-  **Delete** - Touch this button to delete a highlighted item.

After being prompted to make a selection or answer a question, touch the Done button (if available) and then the Advance button to go to the next screen. To go back to a previous screen, touch the Back button. Many selections will require you to touch the Done button before allowing you to advance. If a wrong selection has been made, touch the Delete button or Cancel. Some settings can be made by sliding a bar left or right to decrease or increase a value. You may be required to assign names to equipment. In this case, a keyboard will be displayed and you'll be able to type the desired name. After naming the equipment, save then advance. This method is repeated throughout the Configuration Wizard.



HAYWARD®

Begin the Configuration Wizard

In the initial configuration screen, select the Configuration Wizard that you would like to use (Pre-Programmed, Typical, Advanced, Load Existing). Once selected, follow the guide on the subsequent pages until you have completed the Wizard. At the end of the Wizard, you'll have the opportunity to save your settings or make a change.

NOTE: If additional pool or backyard equipment is added after initial configuration, or you'd like to make a change to an existing saved configuration, re-enter the Configuration Wizard and select "Edit Current Configuration". The initial configuration settings will be retained and you'll have an opportunity to make changes or additions. Be sure to save your configuration when exiting. See page 49 for the Quick Edit Guide.

Connect to Home Network

You will be prompted to connect to your home network after selecting the Configuration Wizard. You can connect either wirelessly or through a wired connection.

Setup a Wireless Connection? Select "Yes" for wireless or "No" for wired, external antenna (using Hayward HLWLAN) or to skip this step.

If Yes is selected - From the Network Connections screen that follows, select the desired access point. Note that a 2.4GHz connection to the router is required. You will then be prompted to input the password for that access point. Once you input the password and press the check mark to continue, a Network Diagnostic screen will appear and the OmniHub will run through a series of checks to verify connection to the access point. When the system is done running through the diagnostics, press the check mark to continue to the next section of the Configuration Wizard.

If No is selected - Choose an option below:

External Antenna - Make this selection when setting up a Hayward HLWLAN. Note that a 2.4GHz connection to the router is required. Once the system is done running through the diagnostics, press the check mark to continue to the next section of the Configuration Wizard.

Wired - For a wired connection, run an Ethernet cable from the Controller to the router (page 23). After selecting "Wired", the system will display the ip address and other network properties. Press the check mark and the OmniHub will verify the network connection. You can now exit back to the main menu and continue with the Configuration Wizard.

Not Now - Skip network setup and continue with Configuration Wizard.

Pre-Programmed Configuration Wizard Guide (use only if filter pump is VSP)

As you progress through the Configuration Wizard, refer to the following information to help answer questions and make selections.

Connect to Home Network - The first thing you will do in the Configuration Wizard is connect to your home network. Refer to the "Connect to Home Network" above for more information on this part of the Configuration Wizard.



HAYWARD®

Configuration Summary - Since you chose the “Pre-Programmed” configuration, you will be brought immediately to the Configuration Summary screen after connecting to your home network. This screen details all of the equipment that you have connected and configured to your OmniHub. Verify that the information on this screen is correct and then press the check mark to continue.

Finished with Configuration - After verifying the configuration summary, you are now finished with configuration and can choose to either save the configuration by pressing “Save and Restart” or make an additional change to the configuration by pressing “Customize / Add Components”. If you choose to edit the configuration, you will be brought to “Quick Edit” interface that allows you to quickly select the equipment that you want to add or modify. See page 49 for information on Quick Edit. Once you finish making your changes, save the configuration by pressing the save button on the bottom of the screen.

Typical Configuration Wizard Guide (use only if filter pump is VSP)

As you progress through the Configuration Wizard, refer to the following information to help answer questions and make selections.

Connect to Home Network - The first thing you will do in the Configuration Wizard is connect to your home network. Refer to the “Connect to Home Network” section on page 27 for more information on this part of the Configuration Wizard.

Time and Date - “Automatically get time and date from internet” and “Automatically adjust for daylight savings time” are enabled by default. It is recommended that you leave them enabled if your OmniHub system has an internet connection. Disabling “Automatically get time and date from internet” will allow you to set the current date and time using a 12hr clock (AM/PM) or 24hr clock (military time). Save by touching the Done button when finished. NOTE: When registering the OmniHub and creating a web account, you’ll be prompted to enter a Time Zone. Be sure to enter the same time zone as the physical location of the OmniHub, otherwise schedules and timers will be inaccurate.

Select Desired Units of Measure (Standard or Metric) - If Standard is selected, temperatures will be displayed in Fahrenheit and chemistry readings will be in ppm. If Metric is selected, temperatures will be displayed in Celsius and chemistry readings will be in g/L.

Select Desired Units of Measure (Speed in % or Speed in RPM) - If Speed in % is selected, then pump speeds will be displayed in %. If Speed in RPM is selected, then pump speeds will be displayed in RPM.

Which Hayward Unique Address? Select the HUA of the filter pump. NOTE: this option only appears if more than one variable speed pump is discovered.

Do you want to control a heater? Select whether or not you have a heater connected to the OmniHub.

If Yes is selected:

What type of heater? Select the type of heater that is connected to the OmniHub. Solar heating is not an option for a Typical configuration -- only Heat Pump and Gas are available.



HAYWARD®

Do You Have a Salt Water Chlorine Generator? *Requires Hayward Aqua Rite*

If Yes is selected:

Type of Cell? Select the type of Hayward TurboCell that is installed in your system.

Where is the Cell Located? If an entry is already shown in the box, touch the Advance button. If no entry is shown, selecting the box will bring you to a table showing the detected chlorinator. Select "AquaRite" and select Done.

Percentage of Output - The OmniHub can only generate chlorine while the filter pump is operating. Set the percentage of run time that you desire chlorine generation. Raise this value to generate more chlorine. Lower this value to generate less.

Would you like to add a relay controlled accessory? Select whether or not you would like to configure an accessory that is wired to a Smart Relay. This can be configured as a water feature, a light (incandescent or ColorLogic), a cleaner, or an accessory.

If Yes is selected:

Select the type of relay controlled accessory (water feature, light (incandescent or ColorLogic), cleaner, accessory).

If Water Feature, Cleaner, or Accessory is selected:

Select Relay: Choose the Smart Relay that will control the water feature. NOTE: this option only appears if more than one Smart Relay is discovered. With only one Smart Relay discovered, the OmniHub will automatically select the relay for you.

If Light is selected:

Type of Light: Choose the type of light that you want to configure. The options are UCL (14V), CL4.0 (115V), CL2.5 (14V), Incandescent, and Other.

Select Relay: Choose the Smart Relay that will control the light. NOTE: this option only appears if more than one Smart Relay is discovered. With only one Smart Relay discovered, the OmniHub will automatically select the relay for you.

If UCL was previously selected:

Would you like to test for Omni Direct capability? For UCL lights manufactured after June 2018, you can select Yes and the OmniHub will test your lights to confirm. If your lights blink white after the test, you can enable Omni Direct mode. If not, the UCL light will default to UCL Standalone mode. Refer to your Universal ColorLogic manual for more information about each mode.

Would you like to add a pump driven accessory? Select whether or not you would like to configure a pump driven accessory. NOTE: this option only appears if more than one variable speed pump is discovered.

If Yes is selected:

Select the type of pump driven accessory (water feature, cleaner, accessory)

If Water Feature, Cleaner, or Accessory is selected:

Which Hayward Unique Address? Select the HUA of the water feature, clean-



HAYWARD®

er, or accessory's variable speed pump. NOTE: this option only appears if more than two variable speed pumps are discovered.

Configuration Summary - The Configuration Summary screen appears once you reach the end of the Configuration Wizard. This screen details all of the equipment that you have connected and configured to your OmniHub. Verify that the information on this screen is correct and then press the check mark to continue.

Finished with Configuration - After verifying the configuration summary, you are now finished with configuration and can choose to either save the configuration by pressing "Save and Restart" or make an additional change to the configuration by pressing "Customize / Add Components". If you choose to edit the configuration, you will be brought to "Quick Edit" interface that allows you to quickly select the equipment that you want to add or modify. See page 49 for information on Quick Edit. Once you finish making your changes, save the configuration by pressing the save button on the bottom of the screen.

Advanced Configuration Wizard Guide

As you progress through the Configuration Wizard, refer to the following information to help answer questions and make selections. Be aware that you may be asked to configure options/features that the OmniHub does not support. If unclear, refer to the "Features" section on page 4 to determine the type of operation that the OmniHub supports. Configuring equipment or functions that are not supported will prevent the OmniHub from working properly.

Connect to Home Network - The first thing you will do in the Configuration Wizard is connect to your home network. Refer to the "Connect to Home Network" section on page 27 for more information on this part of the Configuration Wizard.

Enable Screen Color Changes for System Alerts? To alert the user of warning conditions (no flow, failed sensor, etc.), the OmniHub can change its screen color. The screen can display yellow or red depending on the severity of the condition.

Time and Date - "Automatically get time and date from internet" and "Automatically adjust for daylight savings time" are enabled by default. It is recommended that you leave them enabled if your OmniHub system has an internet connection. Disabling "Automatically get time and date from internet" will allow you to set the current date and time using a 12hr clock (AM/PM) or 24hr clock (military time). Save by touching the Done button when finished. NOTE: When registering the OmniHub and creating a web account, you'll be prompted to enter a Time Zone. Be sure to enter the same time zone as the physical location of the OmniHub, otherwise schedules and timers will be inaccurate.

Select Desired Units of Measure (Standard or Metric) - If Standard is selected, temperatures will be displayed in Fahrenheit and chemistry readings will be in ppm. If Metric is selected, temperatures will be displayed in Celsius and chemistry readings will be in g/L.

Select Desired Units of Measure (Speed in % or Speed in RPM) - If Speed in % is selected, then pump speeds will be displayed in %. If Speed in RPM is selected, then pump speeds will be displayed in RPM.



HAYWARD®

MSP ID - The OmniHub MSP ID number will be displayed. This unique number is used to identify your OmniHub when setting up a web account. A web account is needed to access the OmniHub by your mobile devices. **IMPORTANT:** write down the MSP ID number for future use. The MSP ID number will be needed when entering the configuration wizard after initial configuration as well as entering and exiting Simple Mode. Simple Mode is a customizable screen that can be set up for quick access to pool/spa functions and features.

How many Bodies of Water? The OmniHub can support one or two bodies of water, typically a pool and spa. Select the number and advance. You'll be brought to a screen where you can add, delete or edit a Body of Water. When initially configuring the OmniHub, a "?" will appear in the Body of Water button. You will have to configure this body of water by selecting it and then touching the Advance button. When finished configuring bodies of water, you'll be returned to this same screen. Touch the Done button and advance to the next section of configuration.

IMPORTANT: If selecting two bodies of water, note that the filter pump and heater must be shared for both. The OmniHub does not support more than one filter pump and heater for both the pool and spa. Do not make selections that allow more than one set of equipment.

IMPORTANT: The following instructions are for Body of Water 1 (Pool) configuration. When finished with the first Body of Water, you'll follow the same instructions for the second Body of Water, if previously selected. Configured equipment like a VSP and heater will be shared among both.

What is the Body of Water type? Select the type of Body of Water that you would like to configure. The choices are Pool and Spa.

Name of Body of Water - Selecting the box will allow you to edit the name. During initial configuration, the box will show "Pool". Select the box and then use the keyboard to enter the desired name of the body of water.

Name Filter Pump - Touch the box and use the keyboard to name the filter pump.

What Type of Pump? - Depending on your answer, the OmniHub will use one Smart Relay (single speed pumps), two Smart Relays (two speed pumps) or the low speed communication bus (Hayward supported VSP pumps only) for pump control. Select the type of pump and advance.

If one speed or two speed pump is selected:

Which Relay is it Wired to? If using a single speed or two speed pump, you'll be asked which Smart Relay(s) is wired to the pump. If a value is already shown in the box(es), advance to the next screen. If no value is shown, selecting the box will bring you to a table showing all detected Smart Relays. Select the proper Smart Relay(s) from the table and touch the Done button to proceed. The Smart Relay(s) should now be shown in the box(es) and you can advance to the next screen to continue the pump configuration.

Filter Pump Off for Valve Change? When Yes is selected, the pump will shut off for 35 seconds whenever a valve changes position.

Flow Monitoring Enabled? *Requires use of a Hayward flow switch.* This feature will help



HAYWARD®

protect the filter pump from damage due to no flow. When Yes is selected, the OmniHub will monitor the state of water flow when the filter pump is on. If no flow is detected for more than 15 minutes, the OmniHub will shut down the pool pump and will indicate an error. The error will be cleared the next time the pump is turned on.

Would You Like to Enable Priming? Select whether you want the filter pump to prime when turned on. This will turn the pump on at high speed for a set amount of time to establish normal water flow every time the pump is activated after being off for at least 30 seconds. If **Yes** is selected, the following screen will allow you to choose the length of time the pump will prime. This option only appears if the filter pump is configured as a 2-Speed pump.

Freeze Protection Enabled? Freeze protection is used to protect the pool and plumbed equipment against freeze damage during cold temperatures. If freeze protection is enabled AND the air temperature falls below the freeze threshold, the OmniHub will turn on the filter pump to circulate the water.

If Yes is selected:

Freeze Protect Temperature? Select the temperature to be used for freeze protection. Temperature is adjustable from 33°F-42°F (1°C-6°C). 38°F (3°C) is default. This threshold will be used for all outputs that have freeze protection enabled.

Freeze Protect Speed? For two speed pumps only, select 50% or 100%.

If VSP is selected:

Which Hayward Unique Address? If using a VSP, you'll be asked what is the Hayward Unique Address (HUA). If a value is already shown in the box, advance to the next screen. If no value is shown, selecting the box will bring you to a table showing all detected devices. Select the proper HUA from the table and touch the Done button. If unsure of the HUA, refer to the pump's manual for instructions on how to determine the pump's HUA. Once selected, the address should now be shown in the box and you can advance to the next screen to continue the VSP configuration.

Pump Capacity - Set the minimum and maximum RPM of the pump. Refer to your pump manual for more information.

Permitted User Setting - The OmniHub will automatically calculate these values based on the minimum and maximum RPM that were previously entered. They can be changed as desired.

Speed Presets - Set the Low Pump Speed %, Medium Pump Speed %, and High Pump Speed %, presets. These presets will be used when setting schedules for your pump.

Filter Pump Off for Valve Change? When Yes is selected, the pump will shut off for 35 seconds whenever the valve(s) change position.



HAYWARD®

Flow Monitoring Enabled? *Requires use of a Hayward flow switch.* This feature will help protect the filter pump from damage due to no flow. When Yes is selected, the OmniHub will monitor the state of water flow when the filter pump is on. If no flow is detected for more than 15 minutes, the OmniHub will shut down the pool pump and will indicate an error. The error will be cleared the next time the pump is turned on.

Would You Like to Enable Priming? Select whether you want the filter pump to prime when turned on. This will turn the pump on at high speed for a set amount of time to establish normal water flow every time the pump is activated after being off for at least 30 seconds. If Yes is selected, the following screen will allow you to choose the length of time the pump will prime.

Freeze Protection Enabled? Freeze protection is used to protect the pool and plumbed equipment against freeze damage during cold temperatures. If freeze protection is enabled AND the air temperature falls below the freeze threshold, the OmniHub will turn on the filter pump to circulate the water.

If Yes is selected:

Freeze Protect Temperature? Select the temperature to be used for freeze protection. Temperature is adjustable from 33°F-42°F (1°C-6°C). 38°F (3°C) is default. This threshold will be used for all outputs that have freeze protection enabled.

Freeze Protect Speed? This is the speed of the pump while freeze protection is active. Select the desired pump speed %. NOTE: this option only appears if the pump is a two speed pump or a variable speed pump.

How Many Heaters? - This question is for THIS BODY OF WATER ONLY. For example: If you have 2 heaters, one for the pool Body of Water and one for the spa Body of Water, you would answer "1" to this question. Note that you can have a maximum of 3 heaters/chillers per Body of Water.

If "1" or more is selected:

Heater Cooldown Enabled? This feature ensures that the heater cools down before water circulation is stopped. When enabled, the OmniHub will continue to run the filter pump for 5 minutes after the heater turns off.

Heater Extend Enabled? If "Enabled", the filter extend logic keeps the filter pump running beyond the normal turn-off time until the pool (or spa) is heated up to the desired temperature setting. Heater extend will NOT cause the filter pump to turn on, it will only delay the turn off time when the heater is operating.

Settable Water Temperature Range? This is the maximum and minimum allowed settings for heating and/or cooling.

Select and Configure a Heater At this screen, you can add, delete and configure your heater(s). Select the desired heater, then touch the Advance button. When finished configuring heater(s), you'll be returned to this same screen. Touch the Done button and advance to the next section of configuration. Refer to the following information when configuring heater(s):



HAYWARD®

Do you want to configure a Smart Heater? This option only appears if you have a heater with Omni remote control capability connected to your OmniHub and powered on. Select “Yes” if you would like to configure this heater now or “No” if you would like to configure a different heater.

If Yes is selected:

Which Hayward Unique Address? Select the HUA of the Smart Heater that you would like to configure.

Name Heater Select the box, then type the desired name for your heater. This name will be used when referring to this particular heater.

Does Heater Have a Valve? Select whether or not the heater has an associated valve that will turn on when the heater is activated. If **Yes** is selected, the following screen will ask where the valve is wired.

Minimum Allowed Air Temperature for Heater? If the air temperature falls below this setting, the heater will be prevented from running, regardless of conditions. This feature is especially useful for heat pumps which become less efficient as the outdoor ambient temperature falls.

Minimum Operation Speed? For variable speed pumps, select the lowest pump speed that is allowed while heating. Set a speed that will ensure that there will be sufficient flow for the heater to operate properly. For two speed pumps, you can select if you want to allow the filter pump to run at low speed during heater operation.

What Type? Heater choices are Solar, Heat Pump, Gas, Geothermal, and Electric. Make your selection and advance.

If Gas or Electric Heater is selected:

Name Heater: Select the box, then type the desired name for your heater. This name will be used when referring to this particular heater.

Which Relay is it Wired to? Selecting the box will bring you to a table showing all detected relays. Select the low voltage relay that is wired to the heater (refer to the Connection Table for this information), then advance. The relay should now be shown in the box. Advance to the next screen to continue gas heater configuration.

Does Heater Have a Valve? Select whether or not the heater has an associated valve that will turn on when the heater is activated. If **Yes** is selected, the following screen will ask where the valve is wired.

Heater Priority Duration? This question will appear if more than one heater is configured. Set the amount of time that you will allow the priority heater to heat before allowing the next heater to start. If the priority heater meets the demand within this time frame, the next heater will not be used. Note that a time interval setting of “0” will eliminate priority and always run both heaters at the same



HAYWARD®

time. If a time interval setting of “24” is selected, the next priority heater will not turn on until the first priority heater becomes invalid to run.

Minimum Operation Speed? For variable speed pumps, select the lowest pump speed that is allowed while heating. Set a speed that will ensure that there will be sufficient flow for the heater to operate properly. For two speed pumps, you can select if you want to allow the filter pump to run at low speed during heater operation.

If Heat Pump or Geothermal is selected:

Name Heater: Select the box, then type the desired name for your heater. This name will be used when referring to this particular heater.

Which Relay is it Wired to? Selecting the box will bring you to a table showing all detected relays. Select the low voltage relay that is wired to the heater (refer to the Connection Table for this information), then advance. The relay should now be shown in the box. Advance to the next screen to continue heat pump configuration.

Does Heater Have a Valve? Select whether or not the heater has an associated valve that will turn on when the heater is activated. If **Yes** is selected, the following screen will ask where the valve is wired.

Does Heater Support Cooling? If your Heat Pump or Geothermal Heater supports cooling and you would like to use it to chill your pool/spa water, select **Yes** to this question. If **Yes** is selected, the following screen will ask where the cooling relay is located.

Heater Priority Duration? This question will appear if more than one heater is configured. Set the amount of time that you will allow the priority heater to heat before allowing the next heater to start. If the priority heater meets the demand within this time frame, the next heater will not be used. Note that a time interval setting of “0” will eliminate priority and always run both heaters at the same time. If a time interval setting of “24” is selected, the next priority heater will not turn on until the first priority heater becomes invalid to run.

Minimum Allowed Air Temperature for Heater? (Heat Pump Only) If the air temperature falls below this setting, the heater will be prevented from running, regardless of conditions. This feature is especially useful for heat pumps which become less efficient as the outdoor ambient temperature falls.

Minimum Operation Speed? For variable speed pumps, select the lowest pump speed that is allowed while heating. Set a speed that will ensure that there will be sufficient flow for the heater to operate properly. For two speed pumps, you can select if you want to allow the filter pump to run at low speed during heater operation.



HAYWARD®

If Solar is selected:

Name Heater Select the box, then type the desired name for your heater. This name will be used when referring to this particular heater.

Does the Solar Heater Have a Pump? Select whether the solar heating system has a dedicated recirculation pump. If so, the OmniPL will turn this pump on when the pool temperature is below the heater setting and there is solar heat available.

If Yes is selected:

Which Relay is it Wired to? Selecting the box will bring you to a table showing all detected relays. Select the high voltage relay that is wired to the heater (refer to the Connection Table in for this information), then advance. The relay should now be shown in the box. Advance to the next screen to continue solar heater configuration.

Does the Solar Heater Have a Valve? Select whether the solar heating system has a diverter valve to route pool/spa water through the solar collectors. If so, the OmniPL will rotate this valve when the pool temperature is below the heater setting and there is solar heat available.

If Yes is selected:

Where is the valve wired? Selecting the box will bring you to a table showing all detected low voltage relays. Select the relay that is wired to the solar valve, then advance. The relay should now be shown in the box. Advance to the next screen to continue solar heater configuration.

Where is the Solar Temperature Sensor Located? Selecting the box will bring you to a table showing all detected sensors. Select the solar sensor (usually SENS3), then advance. The sensor should now be shown in the box. Advance to the next screen to continue solar heater configuration.

Heater Priority Duration? This question will appear if more than one heater is configured. Set the amount of time that you will allow the priority heater ("1") to heat before allowing the next heater to start. If the priority heater meets the demand within this time frame, the next heater will not be used. Note that a time interval setting of "0" will eliminate priority and always run both heaters at the same time. If a time interval setting of "24" is selected, the next priority heater will not turn on until the first priority heater becomes invalid to run.

Does Solar Require the Filter Pump to Prime When it First Turns On?

If **Yes** is selected, the filter pump will turn on in high speed for 3 minutes to circulate water to the solar panels when the heater is activated. This setting is especially useful if you do not have a boost pump to push the pool/spa water to the roof.

Minimum Operation Speed? Select the lowest pump speed that is allowed while solar heating. Set a speed that will ensure that there will be sufficient



HAYWARD®

flow for the solar heating system to operate properly. For two speed pumps, you can select if you want to allow the filter pump to run at low speed during heater operation.

Would You Like To Prioritize The Use Of Solar Heating Over Any Other Types? Select *Yes* if you would like your solar heater to always be the number 1 heater priority if multiple heaters are configured.

How Many Chillers? This question is for THIS BODY OF WATER ONLY. For example: If you have 2 chillers, one for the pool and one for the spa, you would answer “1” to this question. Note that you can have a maximum of 3 heaters/chillers per Body of Water.

If “1” or more is selected:

Name Chiller Select the box, then type the desired name for your chiller. This name will be used when referring to this particular chiller.

Is Chiller Wired to a Relay? Select whether or not the Chiller is wired to a relay. If *Yes* is selected, the following screen will ask you to select where the relay is wired.

Does Chiller Have a Valve? Select whether or not the Chiller has an associated valve. If *Yes* is selected, the following screen will ask you to select where the valve is wired.

Chiller Priority Duration? This question will appear if more than one chiller is configured. Set the amount of time that you will allow the priority chiller to cool before allowing the next chiller to start. If the priority chiller meets the demand within this time frame, the next chiller will not be used. Note that a time interval setting of “0” will eliminate priority and always run both chillers at the same time. If a time interval setting of “24” is selected, the next priority chiller will not turn on until the first priority chiller becomes invalid to run.

Minimum Operation Speed? Select the lowest pump speed that is allowed while solar heating. Set a speed that will ensure that there will be sufficient flow for the solar heating system to operate properly. For two speed pumps, you can select if you want to allow the filter pump to run at low speed during heater operation.

Do you have a Sense & Dispense Module? Select *Yes* if a Hayward HL-CHEM (sold separately) is connected to the OmniHub.

If Yes is selected:

The next few screens will configure the OmniHub to use Sense and Dispense. The OmniHub automatically detects smart components like the HL-CHEM, and assigns a Hayward Unique Address. If multiple components are detected, the OmniHub will show a table of devices and prompt you to select the proper device.

Which Hayward Unique Address? If a Hayward Unique Address (HUA) is already shown in the box, touch the Advance button. If no address is shown, selecting the box will bring you to a table showing all detected Sense and Dispense devices. Select the HL-CHEM from the table and touch the Done button to advance. The address should now be shown. Touch the Advance button to continue configuring the OmniHub for use with the HL-CHEM.



HAYWARD®

Does ORP Control Chlorination? If you answer Yes to this, the HL-CHEM will constantly measure ORP and will adjust the pool's chlorine based on a predetermined ORP setpoint that you will select. The system will monitor ORP and automatically generate/dispense the correct amount of chlorine to maintain a desired level. Alternatively, if you answer No but are using a chlorine generator, the HL-CHEM will monitor ORP, but the amount of chlorine generated by the Aqua Rite will be based on a manual setting that you will select.

If Yes is selected:

ORP Setpoint - Set the desired ORP level which is measured in mV. 650mV is the default. The OmniHub will continuously measure ORP and generate/dispense the proper amount of chlorine to maintain this setpoint.

ORP Timeout - Select a timeout interval. If the OmniHub has been chlorinating for more than the selected ORP timeout without reaching the desired level, the chlorinator will turn off and display an alarm. The user must clear the alarm to resume chlorination.

Type of Chlorinator? Select the Hayward TurboCell model (if using an Aqua Rite), Liquid Chlorinator or Tablet Feeder that is installed in your system. Note that a flow switch must be installed and connected directly to the Aqua Rite, if that is the chlorinator selected.

If TurboCell model is selected:

Where is the Cell Located? If an entry is already shown in the box, touch the Advance button. If no entry is shown, selecting the box will bring you to a table showing the detected chlorinator. Select "AquaRite" and select Done.

If Liquid Chlorinator is selected:

Select Relay - Selecting the box will bring you to a table showing all Smart Relays. Select the Smart Relay that is connected to the Liquid Chlorine dispenser.

If Tablet Feeder is selected:

Where is the Valve Wired? - Selecting the box will bring you to a table showing all valve outputs. Find the valve that is connected to the Tablet Feeder. Select the valve and select Done.

If No is selected:

Do You Have a Salt Water Chlorine Generator? *Requires Hayward Aqua Rite*

If Yes is selected:

Type of Cell? Select the type of Hayward TurboCell that is installed in your system.

Where is the Cell Located? If an entry is already shown in the box, touch the Advance button. If no entry is shown, selecting the box will bring you to a table showing the detected chlorinator. Select "AquaRite" and select Done.



HAYWARD®

Percentage of Output - The OmniHub can only generate chlorine while the filter pump is operating. Set the percentage of run time that you desire chlorine generation. Raise this value to generate more chlorine. Lower this value to generate less.

Is pH Reduction Enabled? Select Yes if you have a dispenser connected to the OmniHub that will lower pool water pH.

If Yes is selected:

Are you Using Acid or CO₂? Select one.

How Many Acid/CO₂ Dispensers? Select the number of Acid/CO₂ dispensers in your system.

Which relay is it Wired to? Select the Smart Relay that is wired to the pH dispense/feeder unit.

pH Setpoint - Selecting the box will allow you to change the setpoint (7.5 default). Touch the Advance button when finished.

pH Dispensing Timeout - Select a timeout interval. If the unit has been dispensing for more than the selected timeout without reaching the desired level, pH dispensing will turn off and an alarm will be displayed. Check the chemical supply and the feeder. If both are OK, the timeout may need to be increased. The user must clear the alarm to resume pH dispensing.

pH Extend Enabled - If enabled, the OmniHub will continue to run the filter pump regardless of schedule until the pH level in the pool has reached the setpoint.

How many cleaners? The OmniHub has two actuator outputs. If controlling a pool and spa (two bodies of water), you cannot add a cleaner that requires a valve.

If "1" or more is selected:

Select and Configure a Cleaner At this screen you can add, delete and configure your cleaner(s). Select the desired cleaner, then touch the Advance button. When finished configuring cleaner(s), you'll be returned to this same screen. Touch the Done button to advance to the next section of configuration. Refer to the following information when configuring cleaner(s):

Type of Cleaner? Touch the box and select the type of cleaner used. Choices are Pressure, Suction, Robotic and In-Floor.

Name of Cleaner - Touch the box and use the keyboard to name the cleaner.

Does Cleaner Have a Pump? Select whether the cleaner has a dedicated pump. If so, the OmniHub will turn this pump on when the cleaner is scheduled to run.

If Yes is selected:

What Type? Select the type of pump used. The choices are Single Speed, Two Speed and VSP.



HAYWARD®

If single speed or two speed pump is selected:

Which Relay is it Wired to? Touch the box and select the Smart Relay(s) that is wired to the cleaner pump.

If VSP is selected:

Which Hayward Unique Address? If using a VSP for your cleaner pump, you'll be asked what is the Hayward Unique Address (HUA). If a value is already shown in the box, advance to the next screen. If no value is shown, selecting the box will bring you to a table showing all detected devices. Select the proper HUA from the table and touch the Done button. The address should now be shown in the box and you can advance to the next screen to continue the VSP configuration.

Pump Capacity - Set the minimum and maximum RPM of the pump. Refer to your pump manual for more information.

Permitted User Setting - The OmniHub will automatically calculate these values based on the minimum and maximum RPM that were previously entered. They can be changed as desired.

Speed Presets - Set the Low Pump Speed %, Medium Pump Speed %, and High Pump Speed %, presets. These presets will be used when setting schedules for your pump.

Does Cleaner have a Valve? Select whether the cleaner requires a valve to change position when in use.

If Yes is selected:

How Many? Select how many valves are used for the cleaner.

Where is the Valve(s) Wired? Selecting the box will bring you to a table showing the valve outputs. Select the output(s) that is wired to the cleaner valve(s), then advance. Advance to the next screen to continue.

Would you like your valve(s) to cycle On and Off at a set interval? If you would like the cleaner valve(s) to cycle to a set interval while cleaning, select Yes. Set the interval on the next screen.

Would You Like to Enable Priming? If a VSP or two-speed pump is used, select whether you want the pump to prime when turned on. This will turn the pump on at high speed for a set duration to establish normal water flow every time the pump is activated after being off for at least 30 seconds. This option is only available for two speed and variable speed pumps.

If Yes is selected:

Enter Priming Duration: Input the number of minutes that you want the pump to prime for. This setting is configurable from 0-15 minutes. Once priming has finished, the pump will resume at the previously set speed.



HAYWARD®

Freeze Protection Enabled? Freeze protection is used to protect the pool and plumbed equipment against freeze damage during cold temperatures. If freeze protection is enabled AND the air temperature falls below the freeze threshold (refer to pump configuration), the OmniHub will turn on the cleaner pump to circulate the water.

If Yes is selected:

Freeze Protect Speed? This is the speed of the pump while freeze protection is active. Select the desired pump speed %. NOTE: this option only appears if the pump is a two speed pump or a variable speed pump.

How Many Water Features? Enter the number of water features that you have connected to the OmniHub.

If "1" or more is selected:

Type of Water Feature? Touch the box and select the type of water feature used. Choices are Water Feature, Water Slide, Waterfall, and Fountain.

Name of Water Feature - Touch the box and use the keyboard to name the water feature.

Does Water feature Have a Pump? Select whether the water feature has a dedicated pump. If so, the OmniHub will turn this pump on when the water feature is scheduled to run.

If Yes is selected:

What Type? Select the type of pump used. The choices are Single Speed, Two Speed and VSP.

If single speed or two speed pump is selected:

Which Relay is it Wired to? If using a single speed or two speed pump, you'll be asked which Smart Relay(s) is wired to the pump. If a value is already shown in the box(es), advance to the next screen. If no value is shown, selecting the box will bring you to a table showing all detected Smart Relays. Select the proper Smart Relay(s) from the table and touch the Done button to proceed. The Smart Relay(s) should now be shown in the box(es) and you can advance to the next screen to continue the pump configuration.

If VSP is selected:

Which Hayward Unique Address? If using a VSP for your water feature pump, you'll be asked what is the Hayward Unique Address (HUA). If a value is already shown in the box, advance to the next screen. If no value is shown, selecting the box will bring you to a table showing all detected devices. Select the proper HUA from the table and touch the Done button. If unsure of the HUA, refer to the pump's manual for instructions on how to determine the pump's HUA. Once selected, the address should now be shown in the box and you can advance to the next screen to continue the VSP configuration.

Pump Capacity - Set the minimum and maximum RPM of the pump. Refer to your pump manual for more information.



HAYWARD®

Permitted User Setting - The OmniHub will automatically calculate these values based on the minimum and maximum RPM that were previously entered. They can be changed as desired.

Speed Presets - Set the Low Pump Speed %, Medium Pump Speed %, and High Pump Speed %, presets. These presets will be used when setting schedules for your pump.

Does Water Feature have a Valve? Select whether the water feature requires a valve to change position when in use.

If Yes is selected:

How Many? Select how many valves are used for the water feature.

Where is the Valve(s) Wired? Selecting the box will bring you to a table showing the valve outputs. Select the output(s) that is wired to the cleaner valve(s). Advance to the next screen to continue.

Would You Like to Enable Priming? If a VSP or two-speed pump is used, select whether you want the pump to prime when turned on. This will turn the pump on at high speed for a set duration to establish normal water flow every time the pump is activated after being off for at least 30 seconds.

If Yes is selected:

Enter Priming Duration: Input the number of minutes that you want the pump to prime for. This setting is configurable from 0-15 minutes. Once priming has finished, the pump will run in the speed that it was chosen to run at.

Freeze Protection Enabled? Freeze protection is used to protect the pool and plumbed equipment against freeze damage during cold temperatures. If freeze protection is enabled AND the air temperature falls below the freeze threshold (refer to pump configuration), the OmniHub will turn on the water feature pump to circulate the water.

If YES is selected:

Freeze Protect Speed? This is the speed of the pump while freeze protection is active. Select the desired pump speed %. NOTE: this option only appears if the pump is a two speed pump or a variable speed pump.

Would You Like To Configure A Default Startup Speed For Water Feature? If the water feature has a valve and the system uses a VSP filter pump, the OmniHub allows you to set a startup pump speed for the water feature, regardless of the pump's schedule. The speed will change at the next scheduled interval.

Do You Want to Configure Any Lights? Select yes if you are using any type of pool or spa lights. The options are Universal ColorLogic (UCL), ColorLogic 4.0 (CL4.0), ColorLogic 2.5 (CL2.5), Water-Bowl, Pentair Color LED (P-COLOR), Jandy Color LED (Z-Color), Incandescent, and Other. Transformers powering Universal ColorLogic lights must all be connected to the same high voltage relay for synchronization to function properly. If using Omni Direct mode, you must use an internal relay, not an HLRELAYBANK. Note that the OmniHub can only support ColorLogic lights in Standalone mode



HAYWARD®

and Omni Direct mode using its Smart Relays. This requires power cycling so although more than one set of ColorLogic lights can be wired to the same relay, do not connect any other device to relays that are controlling ColorLogic lights.

If Yes is selected:

What Kind of Lights? Touch the box to select the type of lights that will be used. UCL (14V), CL4.0 (115V), CL2.5 (14V), WaterBowl, P-Color, Z-Color, Incandescent, and Other.

Name the Group of Lights - Touch the box and use the keyboard to name the lights.

How Many Relays are Lights Wired to? Select the number of relays used by the lights.

Which Relay is it Wired to? Touch the box to select the Smart Relay that is wired to the lights. If the lights are connected to a Smart Power Transformer, select the zone(s) that the lights are wired to.

If UCL was previously selected:

Would you like to test for Omni Direct capability? For UCL lights manufactured after June 2018, you can select Yes and the OmniHub will test your lights to confirm. If your lights blink white after the test, you can enable Omni Direct mode. If not, the UCL light will default to UCL Standalone mode. Note that if you are configuring a WaterBowl light, the Flicker feature will only be available if the light is set to OmniDirect mode.

How Many Pool Accessories? Select the number of accessories that will be used for this Body of Water only. You'll have an opportunity to configure accessories for the spa and also the backyard at a later point.

If "1" or more is selected:

Select and Configure Accessories At this screen you can add, delete and configure your accessories. Select the desired accessory, then touch the Advance button. When finished configuring accessories, you'll be returned to this same screen. Touch the Done button and advance to the next section of configuration. Refer to the following information when configuring accessories:

Type of Accessory? Touch the box and select the type of accessory used. Choices are Laminals, Jets, Blower and Other.

Name of Accessory - Touch the box and use the keyboard to name the accessory.

Does Accessory Have a Pump? Select whether the accessory has a dedicated pump. If so, the OmniHub will turn this pump on when the accessory is scheduled to run.

If Yes is selected:

What Type? Select the type of pump used. The choices are Single Speed, Two Speed and VSP.

If single speed or two speed pump is selected:

Which Relay is it Wired to? If using a single speed or two speed pump, you'll be asked which relay(s) is wired to the pump. If a value is already shown in the box(es), advance to the next screen. If no



HAYWARD®

value is shown, selecting the box will bring you to a table showing all detected relays. Select the proper relay(s) from the table and touch the Done button. The relay(s) should now be shown in the box(es) and you can advance to the next screen to continue the pump configuration.

If VSP is selected:

Which Hayward Unique Address? If using a VSP for your accessory pump, you'll be asked what is the Hayward Unique Address (HUA). If a value is already shown in the box, advance to the next screen. If no value is shown, selecting the box will bring you to a table showing all detected devices. Select the proper HUA from the table and touch the Done button. The address should now be shown in the box and you can advance to the next screen to continue the VSP configuration.

Pump Capacity - Set the minimum and maximum RPM of the pump. Refer to your pump manual for more information.

Permitted User Setting - The OmniHub will automatically calculate these values based on the minimum and maximum RPM that were previously entered. They can be changed as desired.

Speed Presets - Set the Low Pump Speed %, Medium Pump Speed %, and High Pump Speed %, presets. These presets will be used when setting schedules for your pump.

Does Accessory have a Valve? Select whether the accessory requires a valve to change position when in use.

If Yes is selected:

How Many? Select how many valves are used for the accessory.

Where is the Valve(s) Wired? Selecting the box will bring you to a table showing all detected low voltage relays. Select the relay(s) that is wired to the accessory valve(s), then advance. The valve(s) should now be shown in the box. Advance to the next screen to continue accessory configuration.

Would You Like to Enable Priming? If a VSP or two-speed pump is used, select whether you want the pump to prime when turned on. This will turn the pump on at high speed for a set duration to establish normal water flow every time the pump is activated after being off for at least 30 seconds.

If Yes is selected:

Enter Priming Duration: Input the number of minutes that you want the pump to prime for. This setting is configurable from 0-15 minutes. Once priming has finished, the pump will run in the speed that it was chosen to run at.



HAYWARD®

Freeze Protection Enabled? Freeze protection is used to protect the pool and plumbed equipment against freeze damage during cold temperatures. If freeze protection is enabled AND the air temperature falls below the freeze threshold (refer to pump configuration), the OmniHub will turn on the accessory pump to circulate the water.

If Yes is selected:

Freeze Protect Speed? This is the speed of the pump while freeze protection is active. Select the desired pump speed %. NOTE: this option only appears if the pump is a two speed pump or a variable speed pump.

Would You Like To Configure A Default Startup Speed For the Accessory? If the accessory has a valve and the system uses a VSP filter pump, the OmniHub allows you to set a startup pump speed for the accessory, regardless of the pump's schedule. The speed will change at the next scheduled interval.

Do You Have an Air Temperature Sensor? Select whether there is an air temperature sensor wired to the OmniHub.

If Yes is selected:

Where is the Sensor Wired? Touching the box will bring you to a table showing all detected sensors connections. Select the sensor connection used for the air sensor (typically SENS2) and touch the Done button. The sensor connection should now be shown in the box and you can advance to the next screen to continue configuration.

Do You Have a Water Temperature Sensor? Select whether there is a water temperature sensor wired to the OmniHub.

If Yes is selected:

Where is the Sensor Wired? Touching the box will bring you to a table showing all detected sensors connections. Select the sensor connection used for the water sensor (typically SENS1) and touch the Done button. The sensor connection should now be shown in the box and you can advance to the next screen to continue configuration.

Do You Have a Flow Switch? Select whether there is a flow switch wired to the OmniHub.

If Yes is selected:

Where is the Sensor Wired? Touching the box will bring you to a table showing all detected sensors connections. Select the sensor connection used for the flow switch (typically FLOW SWITCH 1) and touch the Done button. The sensor connection should now be shown in the box and you can advance to the next screen to continue configuration.

Select and Configure Sensors At this screen you can add, delete and configure your sensors. Select the desired sensor, then touch the Advance button. When finished configuring sensors, you'll be returned to this same screen. Touch the Done button and advance to the next section of configuration. Refer to the following information when configuring sensors:

Where is the Sensor Located? Touch the box and go to the table showing the Bodies of Water and the Backyard. Select the location where the sensor is installed.

What Type of Sensor? Select the type of sensor. Choices are Air, Water, Flow or Solar.

Name Sensor - Touch the box and use the keyboard to name the sensor.



HAYWARD®

Where is the Sensor Wired? Touching the box will bring you to a table showing all detected sensors connections. Select the sensor connection used for the sensor and touch the Done button. The sensor connection should now be shown in the box and you can advance to the next screen to continue configuration.

Do You Want to Configure Any Backyard Lights? Select yes if you are using any type of lights in the backyard. The options are Universal ColorLogic (UCL), ColorLogic 4.0 (CL4.0), ColorLogic 2.5 (CL2.5), WaterBowl, Pentair Color LED (P-COLOR), Jandy Color LED (Z-Color), Incandescent, and Other. Note that the OmniHub can only support lights in Standalone mode using its high voltage relays.

If Yes is selected:

What Kind of Lights? Touch the box to select the type of lights that will be used. The options are UCL (14V), CL4.0 (115V), CL2.5 (14V), WaterBowl, P-Color, Z-Color, Incandescent, and Other.

Name the Group of Lights - Touch the box and use the keyboard to name the lights.

How Many Relays are Lights Wired to? Select the number of relays used by the lights.

Which Relay is it Wired to? Touching the box(es) will bring you to a table showing all detected relays. Select the relay(s) that are connected to the lights and touch the Done button. If the lights are connected to a Smart Power Transformer, select the zone(s) that the lights are wired to. The relay(s) should now be shown in the box(es) and you can advance to the next screen to continue configuration.

If UCL was previously selected:

Would you like to test for Omni Direct capability? For UCL lights manufactured after June 2018, you can select Yes and the OmniHub will test your lights to confirm. If your lights blink white after the test, you can enable Omni Direct mode. If not, the UCL light will default to UCL Standalone mode. Note that if you are configuring a WaterBowl light, the Flicker feature will only be available if the light is set to OmniDirect mode.

How Many Accessories are in the Backyard? Select the number of accessories that will be used for the backyard.

If "1" or more is selected:

Select and Configure Accessories At this screen you can add, delete and configure your accessories. Select the desired accessory, then touch the Advance button. When finished configuring accessories, you'll be returned to this same screen. Touch the Done button and advance to the next section of configuration. Refer to the following information when configuring accessories:

Name of Accessory - Touch the box and use the keyboard to name the accessory.

Which Relay is it Wired to? Touching the box will bring you to a table showing all detected Smart Relays. Select the Smart Relay that is connected to the accessory and touch the Done button.

NOTE: Do not use the OmniHub to control fire pits or any other fire related equipment.



HAYWARD®

Would You Like to Add an Interlock? An interlock will allow the OmniHub to turn on or to turn off a piece of pool equipment (slave) based on the state of other pool equipment (master). An example of this would be the desire to turn on walkway lighting (slave) every time the pool deck lights (master) are turned on. This equipment could have been wired together to accomplish the same function, but by interlocking the walkway lights to the deck lights, you'll maintain the ability to turn on the walkway lights independently. An interlock can also control pool equipment based on the state of a temperature sensor, flow switch or external input (normally open/closed switch). An example of this would be to turn on a cabana fan (affected) whenever the outside temperature sensor reads above 90°F. Or, turning on a bug lamp (affected) when a photo sensor (monitored) detects that it is dusk.

If Yes is selected:

Select an Interlock Type - From this screen, select the type of interlock that you would like to configure. The choices are: Equipment to Equipment, Equipment to Sensor, Equipment to Mode, Theme to Sensor, Spillover to External Input and Pool Cover Interlock. Note that interlocks are only selectable if the equipment/features used in that interlock are available. For example, if there are no Themes configured, the Theme to Sensor interlock is not selectable.

If Equipment to Equipment is selected:

To configure the interlock, you'll be asked a series of questions. The questions will vary depending on the equipment that will be configured and cannot all be covered in this manual. In general, you'll select equipment that will be monitored and equipment that will be affected. The equipment could be pumps, valves, heaters, lights, etc. The affected equipment will activate/deactivate depending on the state of the monitored equipment. Advance through the configuration and when finished, a summary screen will be displayed. The summary will describe how the interlocked equipment will function. Read through the description and make sure the equipment will function as desired.

If Equipment to Sensor is selected:

This interlock is similar to above, but the monitored equipment will be a sensor. The monitored sensor can be any sensor, flow switch or external input that has been configured for use with the OmniHub. The affected equipment will activate/deactivate depending on the state of the monitored sensor. For flow switch sensors, affected equipment will turn on/off when the flow switch detects flow or no flow. For temperature sensors, affected equipment will activate/deactivate when the temperature is higher or lower than a desired setpoint. For external inputs, affected equipment will turn on/off when the switch is actuated. Advance through the configuration and when finished, a summary screen will be displayed. The summary will describe how the interlocked equipment will function. Read through the description and make sure the equipment will function as desired.

If Equipment to Mode is selected:

With Equipment to Mode interlock, affected equipment will activate/deactivate based on which mode the OmniHub is in; Pool, Spa or Spillover. You can configure this interlock to turn on/off equipment whenever the OmniHub goes into one of these available modes. Advance through the configuration and when finished, a summary screen will be displayed. The summary will describe how the interlocked equipment will function. Read through the description and make sure the equipment will function as desired.



HAYWARD®

If Theme to Sensor is selected (at least one Theme must be configured, see Operation Manual):

This interlock is similar to the Equipment to Sensor interlock but a Theme is affected instead. As explained in the Operation manual, Themes are created to execute many pool functions with a single button. With a Theme to Sensor interlock, the Theme will run or stop depending on the state of the monitored sensor. For flow switch sensors, the Theme will run or stop when the flow switch detects flow or no flow. For temperature sensors, the Theme will run or stop when the temperature is higher or lower than a desired setpoint. For external inputs, the Theme will run or stop when the switch is actuated. Advance through the configuration and when finished, a summary screen will be displayed. The summary will describe how the interlocked Theme will function. Read through the description and make sure the equipment will function as desired.

If Spillover to External Input is selected (requires that you have an external input configured):

This interlock prevents Spillover mode when an external input (most commonly a pool cover sensor) is actuated. By interlocking Spillover to the pool cover sensor, you'll ensure that water cannot spill into the pool when the cover is in the closed position. A summary screen will be displayed after configuring this interlock. Read through the description and make sure the interlock will function as desired.

If Pool Cover Interlock is selected (if using an automatic pool cover):

This interlock makes it easy to assign specific pool settings when the cover is closed. Pump speed, heater temperature and chlorination percentage can all be preset for periods when the pool cover sensor (external input) detects that the cover is closed. Some or all of these options may not appear if you don't have a variable speed pump, heater or if not using chlorination. An alternative to this interlock is using a Theme to Sensor interlock. Create a Theme using desired settings when the pool cover is closed, then interlock the Theme to the pool cover sensor. A summary screen will be displayed after configuring this interlock. Read through the description and make sure the interlock will function as desired.

Configuration Summary The OmniHub displays all configured equipment in a table for you to view. Scroll through all configured devices and make sure they've been properly assigned.

Finished with Configuration Now that all equipment has been configured, select the following:

Customizing / Add Components - use this selection to go back into Configuration and make changes.

Save and Restart - this selection will save your configuration settings and restart the Omni-Hub.



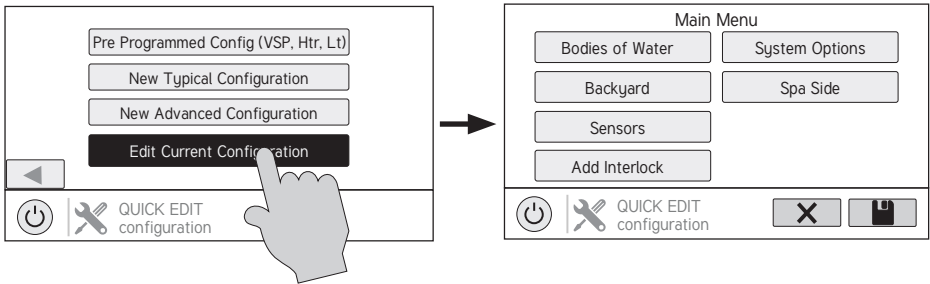

Quick Edit Guide

If additional pool or backyard equipment is added after initial configuration, or you'd like to make a change to an existing configuration setting, re-enter the Configuration Wizard and select "Edit". After selecting "Edit", you will be brought to the Quick Edit Main Menu screen as shown below. Quick Edit allows you to go directly to the equipment that you'd like to add/remove/configure. When you have finished editing the configuration, you will return to this screen to save your changes.



Navigation

There are a number of additional buttons that appear in Quick Edit that either have functions unique to Quick Edit or do not appear anywhere else in the system. These buttons are as follows:

-  **Save** - Touch this button to save the configuration edit. This button only appears on the Quick Edit Home screen.
-  **Cancel** - Touch this button to cancel any changes made to the configuration and exit Quick Edit. This button only appears on the Quick Edit Home Screen.
-  **Home** - Touch this button to quickly jump back to the Quick Edit Main Menu Screen to save your changes. This button appears at the end of every configuration pathway.
-  **Back** - Touch this button to go back to the previous set of configurable items.

As you are using Quick Edit, you will notice that at the end of each pathway, a Home button and a Back button will appear. If you are finished making changes, press the Home button and then press the Save button to save your configuration. If you would like to make more changes to the same device, press the Back button. This will take you back to the last screen of configurable items for that device. If you would like to continue to make changes, but to a different device, press the Home button and then follow the pathway to the new device. The following pages will explain each configuration pathway.



HAYWARD®

Begin Using Quick Edit

From the Quick Main Menu Screen, select one of the following buttons and follow the directions on the next page to configure your equipment.

- Bodies of Water
- Backyard
- Sensors
- Interlocks/Add Interlock
- System Options
- Spa Side

If Bodies of Water is selected:

Select the Equipment that you would like to configure - The options are as follows: Filter Pumps, Heaters, Cleaners, Water Features, Standalone Lights, Accessories, and Other Options. If the equipment is not already configured, then the buttons will appear as Add Heater, Add Cleaner, etc. When the button is pressed with the word "Add" before it, then you will be taken through the full configuration for that equipment as appears in the Advanced Configuration Wizard section of this manual. Otherwise:

If Filter Pumps is selected:

Select the Filter Pump setting that you would like to add/modify - the options are described below.

Name - Create a custom name if desired.

Type - Change the type of Filter Pump that is configured (Single Speed, 2-Speed, or VSP)

HUA - Match the HUA (Hayward Unique Address) to the configured Filter Pump. This option only appears if the Filter Pump is configured as a variable speed pump.

Speed - Change the minimum and maximum allowed speeds of the Filter Pump as well as the Low, Medium and High speed settings. This option only appears if the Filter Pump is configured as a variable speed pump.

Relay - Select the relay(s) that is wired to the Filter Pump. This option only appears if the Filter Pump is configured as a single speed or 2-speed pump.

Off for Valve Change - Select whether you want the Filter Pump to shut off while valves are turning.

Flow Monitoring - Select whether you want flow to be monitored.

Priming - Select whether you want the Filter Pump to prime and the desired duration. This option only appears if the Filter Pump is configured as a 2-speed or variable speed pump.



Freeze Protect - Select whether you want the Filter Pump to turn on for freeze protection. Also set the freeze protect air temperature threshold from this menu. Freeze protect operation can be overridden for a 60 minute period. (See Operation manual for more information).

If Heating/Cooling is selected:

Add a Heater - Pressing “Add a Heater” from this screen will take you through the full configuration for adding a new heater. These steps are described in the Advanced Configuration Wizard section of this manual.

Add a Chiller - Pressing “Add a Chiller” from this screen will take you through the full configuration for adding a new chiller. These steps are described in the Configuration Wizard portion of this manual.

General Heater Options - Pressing this button will take you to a screen with the following general options for heater operation:

Extend - If “Enabled”, the filter extend logic keeps the filter pump running beyond the normal turn-off time until the water is heated up to the desired temperature setting. Heater extend will NOT cause the filter pump to turn on, it will only delay the turn off time when the heater is operating.

Cooldown - This feature ensures that the heater cools down before water circulation is stopped. When enabled, the OmniHub will continue to run the filter pump for 5 minutes after the heater turns off.

Max Temperature - Select the maximum allowed heater setpoint temperature.

Select a Heater/Chiller - Once you select a heater/chiller, all of the options for that heater/chiller will appear on the next screen. These options are as follows:

Name - Create a custom name if desired.

HUA - Select the HUA of the Smart Heater. This option only appears if a Smart Heater is configured.

Type - Select the type of heater that is configured (Solar, Heat Pump, Gas, Geothermal, Electric).

Relay - Select the relay that the heater/chiller is wired to. Option not available for Solar heaters.

Valve - Configure the heating/cooling valve, if used.

Min Filter Speed - Select the minimum speed that the Filter Pump will run while the heater/chiller is active. This option is only available for 2-speed and VSP pumps.



HAYWARD®

Min Air Temperature - Select the minimum air temperature that the heater will be allowed to run. This option is only available if the heater is configured as a Heat Pump.

Priority Duration - Select the number of hours that this heater/chiller will run before the secondary heater/chiller turns on.

Pump - Configure the boost pump for the heater. This option is only available if the heater is configured as a Solar heater.

Valve - Configure the heating valve, if used. This option is only available if the heater is configured as a Solar heater.

Solar Sensor - Configure the solar sensor. This option is only available if the heater is configured as a Solar heater.

Delete a Heater/Chiller - From this screen, if you wish to delete a heater/chiller that is currently configured, select the Delete button can on the right of the name of the heater/chiller that you wish to delete.

If Chemistry is selected:

pH - Once you select pH, all of the options for pH dispensing will appear on the next screen. These options are as follows:

Reduction ON - Select whether you want pH reduction to be enabled.

Chemical Type - Select the type of chemical that is being dispensed (acid or CO₂).

pH Dispensers - Configure the pH dispense unit.

pH Timeout - Choose the pH timeout time.

pH Extend - Select whether you want pH extend enabled for this Body of Water.

Chem Sense Module - Once you select Chem Sense Module, you will be able to select the HUA of your Chem Sense Module you are using from the next screen.

Chlorination - Once you select Chlorination, all of the options for chlorination will appear on the next screen. These options are as follows:

Dispenser Type - Select the type of dispenser used (T-CELL model, liquid chlorinator or tablet feeder).

Dispenser Relay or Valve - Depending on your dispenser type, select the output that controls the dispenser.



HAYWARD®

ORP Timeout - Choose the ORP timeout time and desired ORP setpoint. This option is only available if ORP controls chlorination.

Delete Chem Sense Module/Chlorination - From this screen, if you wish to delete any currently configured chemistry options, select the Delete button on the right of the name of the item that you wish to delete.

NOTE: If either pH dispensing or chlorination are not configured, then this screen will give you the option to “Add CSM” or “Add Chlorination.” If either of those options are selected, then you will be taken through the full configuration for that equipment as appears in the Configuration Wizard portion of this manual.

If Cleaners is selected:

Add Cleaner - Pressing “Add Cleaner” from this screen will take you through the full configuration for adding a new cleaner. These steps are described in the Advanced Configuration Wizard section of this manual.

Select a Cleaner - Once you select a cleaner, all of the options for that cleaner will appear on the next screen. These options are as follows:

Name - Create a custom name if desired.

Type - Select the type of cleaner that is configured (Pressure, Suction, Robotic, In Floor).

Pump - Configure the cleaner pump, if used.

Relay - Select the Smart Relay that is wired to the cleaner. This option only appears if the cleaner does not have an associated pump configured.

Valve - Configure the cleaner valve, if used.

Freeze Protect - Select whether you want the cleaner to turn on for Freeze Protection. Also set the Freeze Protect air temperature threshold from this menu.

Valve Cycle - Configure the valve cycling time period for the cleaner. This option is only available if the cleaner has an assigned valve.

Speed - Change the minimum and maximum allowed speeds of the cleaner as well as the Low, Medium and High speed settings. This option only appears if the cleaner pump is configured as a variable speed pump.

Priming - Select whether you want the cleaner pump to prime and the desired duration. This option only appears if the cleaner pump is configured as a 2-Speed or VSP.



Delete a Cleaner - From this screen, if you wish to delete a cleaner that is currently configured, select the Delete button on the right of the name of the cleaner that you wish to delete.

If Water Features is selected:

Add Water Feature - Pressing “Add Water Feature” from this screen will take you through the full configuration for adding a new water feature. These steps are described in the Advanced Configuration Wizard section of this manual.

Select a Water Feature - Once you select a water feature, all of the options for that water feature will appear on the next screen. These options are as follows:

Name - Create a custom name if desired.

Type - Change the type of water feature that is configured (Waterfall, Waterslide, etc.).

Pump - Configure the water feature pump, if used.

Relay - Select the relay that is wired to the water feature. This option appears only if the water feature does not have an associated pump configured.

Valve - Configure the water feature valve, if used.

Speed - Change the minimum and maximum allowed speeds of the water feature pump as well as the Low, Medium and High speed settings. This option only appears if the water feature pump is configured as a VSP.

Priming - Select whether you want the water feature pump to prime and the desired duration. This option is only available if the water feature pump is configured as a 2-Speed or VSP.

Freeze Protect - Select whether you want the water feature to turn on for Freeze Protection. Also set the Freeze Protect air temperature threshold from this menu.

Default Startup Speed - Select the speed that the filter pump will run at when the water feature is turned on.

Delete a Water Feature - From this screen, if you wish to delete a water feature that is currently configured, select the Delete button on the right of the name of the water feature that you wish to delete.

If Standalone Lights is selected:

Add Standalone Light - Pressing “Add Standalone Light” from this screen will take you through the full configuration for adding new lights. These steps are described in the Configuration Wizard portion of this manual.



HAYWARD®

Select an Existing Group of Lights - Once you select a group of existing lights, all of the options for those lights will appear on the next screen. These options are as follows:

Name - Create a custom name if desired.

Type - Select the type of lights configured.

Relay - Select the Smart Relay that is wired to the group of lights. If using a Smart Power Transformer, select the zone(s) that the lights are wired to.

Set Mode - Set the mode of the lights configured.

Omni Direct - If UCL was previously selected, this button will appear and allow you to test whether your UCL lights are Omni Direct compatible (lights built after June 2018). Note that if you are configuring a WaterBowl light, the Flicker feature will only be available if the light is set to OmniDirect mode.

Delete an Existing Group of Lights - From this screen, if you wish to delete a group of lights that is currently configured, select the group and then select the trash can button next to it.

If Accessories is selected:

Add Accessory - Pressing "Add Accessory" from this screen will take you through the full configuration for adding a new accessory. These steps are described in the Advanced Configuration Wizard section of this manual.

Select an Accessory - Once you select an accessory, all of the options for that accessory will appear on the next screen. These options are as follows:

Name - Create a custom name if desired.

Type - Select the type of accessory configured (Laminar, Dimmer, etc.).

Pump - Configure the accessory pump, if used.

Valve - Configure the accessory valve, if used.

Speed - Change the minimum and maximum allowed speeds of the accessory pump as well as the Low, Medium and High speed settings. This option only appears if the accessory pump is configured as a VSP.

Priming - Select whether you want the accessory pump to prime and the desired duration. This option is only available if the accessory pump is configured as a 2-Speed or VSP.

Freeze Protect - Select whether you want the accessory to turn on for Freeze



HAYWARD®

Protection. Also set the Freeze Protect air temperature threshold from this menu.

Relay - Select the Smart Relay that is wired to the accessory. This option only appears if the accessory does not have an associated pump configured.

Default Startup Speed - Select the speed that the filter pump will run at when the accessory is turned on.

Delete an Accessory - From this screen, if you wish to delete an accessory that is currently configured, select the Delete button on the right of the name of the accessory that you wish to delete.

If Other Options is selected:

Name - Create a custom name if desired.

If Backyard is selected:

Select the Equipment that you would like to configure - The options are Add Standalone Light and Add Accessory. The configuration for these are described in the Configuration Wizard portion of this manual.

If Standalone Light is selected:

Add Standalone Light - Pressing "Add Standalone Light" from this screen will take you through the full configuration for adding new lights. These steps are described in the Configuration Wizard portion of this manual.

Select an Existing Group of Lights - Once you select a group of existing lights, all of the options for those lights will appear on the next screen. These options are as follows:

Name - Rename the group of lights to whatever name is desired.

Type - Select the type of lights configured.

Relay - Select the relay(s) that the group of lights is wired to. If using a Smart Power Transformer, select the zone(s) that the lights are wired to.

Set Mode - Set the mode of the lights configured.

Omni Direct - If UCL was previously selected, this button will appear and allow you to test whether your UCL lights are Omni Direct compatible (lights built after June 2018). Note that if you are configuring a WaterBowl light, the Flicker feature will only be available if the light is set to OmniDirect mode.

Delete an Existing Group of Lights - From this screen, if you wish to delete a group of lights that is currently configured, select the group and then select the trash can button next to it.



HAYWARD®

If Accessories is selected:

Add Accessory - Pressing “Add Accessory” from this screen will take you through the full configuration for adding a new accessory to the Backyard. These steps are described in the Configuration Wizard portion of this manual.

Select an Accessory - Once you select an accessory, all of the options for that Backyard accessory will appear on the next screen. These options are as follows:

Name - Rename the accessory to whatever name is desired.

Relay - Select the relay that the accessory is wired to.

Delete an Accessory - From this screen, if you wish to delete an accessory that is currently configured, select the trash can on the right of the name of the accessory that you wish to delete.

NOTE: The system does not allow you to configure a pump or a valve to accessory equipment in the Backyard.

If Sensors is selected:

Add Sensor - Pressing “Add Sensor” from this screen will take you through the full configuration for adding a new sensor. These steps are described in the Advanced Configuration Wizard section of this manual.

Select a Sensor - Once you select a sensor, all of the options for that sensor will appear on the next screen. These options are as follows:

Name - Create a custom name if desired.

Location - Select the location that the sensor is wired to.

Delete a sensor - From this screen, if you wish to delete a sensor that is currently configured, select the Delete button on the right of the name of the sensor that you wish to delete.

If Interlock/Add Interlocks is selected:

Add Interlock - Pressing “Add Interlock” from this screen will take you through the full configuration for adding a new interlock. These steps are described in the Configuration Wizard portion of this manual.

Select an Interlock - Selecting an interlock from this screen will allow you to view that interlock’s configuration. However, you cannot edit a pre-existing interlock. In order to change an interlock’s configuration, you have to delete the obsolete interlock and create a new one.

Delete an Interlock - From this screen, if you wish to delete an interlock that is currently configured, select the Delete button to the right of the name of the interlock that you wish to delete.

NOTE: If there are no interlocks configured on your system, then the button will appear as “Add Interlock” instead of “Interlocks”. In this case, pressing “Add Interlock” will take you through



HAYWARD®

the full configuration for adding a new interlock. These steps are described in the Advanced Configuration Wizard section of this manual. Once an interlock has been created, the button will say "Interlocks".

If System Options is selected:

Modify Network Setup - Press this button to modify or setup a wired, wireless or external antenna connection.

Would you like to set up a network Connection now? Select the type of connection you would like to set up/modify or select "Not Now". For external antenna connections, you must have a Hayward HLWLAN connected to the OmniHub. "Wired" requires an ethernet connection to the router.

Wireless - If not connected to a network, selecting this button will run a scan of all available wifi networks. Select the desired network and enter a password to connect. Note that a 2.4GHz connection to the router is required. If already connected to a wifi network, selecting this button will present these four options:

Forget Network - This selection allows you to delete saved access points and will prevent the OmniHub from automatically connecting to the deleted wifi network.

Change Password - This selection will allow you to enter a new wifi password. Use this option if you've changed the wifi password on your router/access point.

Network Properties - Network properties will allow you to set a static ip address for the OmniHub. The OmniHub will default to a dynamic ip connection and display current network information such as the local/gateway ip addresses. If a static connection is desired, select "Static" and enter the required network information.

Diagnostic - This selection will re-establish a connection to your wireless network and display current network information such as wifi SSID, signal strength, and the local/gateway ip addresses.

Wired - For a wired connection, run an Ethernet cable from the Controller to the router (page 23). After selecting "Wired", the system will display the ip address and other network properties. Press the check mark and the OmniHub will verify the network connection. You can now exit back to the main menu and continue with the Configuration Wizard.

External Antenna - Make this selection when setting up a Hayward HLWLAN. Note that a 2.4GHz connection to the router is required. Once the system is done running through the diagnostics, press the check mark to continue to the next section of the Configuration Wizard.

Not Now - Skip network setup and continue with Configuration Wizard.



HAYWARD®

Mood Color - To alert the user of warning conditions (no flow, failed sensor, etc.), the OmniHub can change its screen color. The screen can display yellow or red depending on the severity of the condition.

Simple Mode - Use this selection to enable and disable icons to be displayed while in Simple Mode screen. For more information, refer to the Simple Mode section in the Operation manual. *If Spa Side is selected (requires HLSPASIDE):*

Spa Side - Press this button to setup or modify a HLSPASIDE remote control.

Select an Aux button to configure - The 3 Aux buttons on the HLSPASIDE can be configured to run equipment, favorites or themes. In some cases, these buttons may be assigned to default functions. To change functions or assign a new function, select the button that you'd like to configure.

If an Aux button is selected:

Select Function - There are 4 options available.

Equipment - Pressing this button will bring you to a screen that shows all available equipment. Select the desired equipment that you want to assign to the Aux button.

Favorite - Pressing this button will bring you to a screen that shows all available Favorites. These Favorites had to have been defined prior to configuring the Aux buttons. Select the desired Favorite that you want to assign to the Aux button.

Theme - Pressing this button will bring you to a screen that shows all available Themes. These Themes had to have been defined prior to configuring the Aux buttons. Select the desired Theme that you want to assign to the Aux button

Unconfigured - If set to "Unconfigured", the Aux button will have no function.



HAYWARD®



HAYWARD®

Control Pad Mounting Template

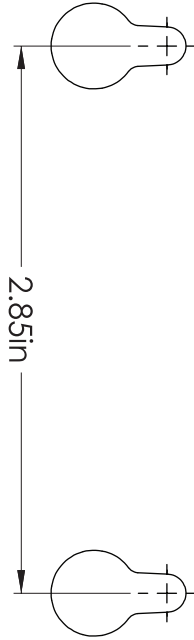



HAYWARD®

LIMITED WARRANTY (effective 03/01/12) Hayward warrants its OmniLogic, OmniHub, Pro Logic, OnCommand and E-Command pool automation products as well as its Aqua Rite, Aqua Rite Pro, Aqua Plus and SwimPure chlorination products to be free of defects in materials and workmanship, under normal use and service, for a period of three (3) years. Hayward also warrants its Aqua Trol chlorination products to be free of defects in materials and workmanship, under normal use and service for a period of one (1) year. These warranties are applicable from the initial date of purchase on private residential swimming pools in the US and Canada. Installations of product for use on commercial pools in the US and Canada is covered for a period of one (1) year for defects in materials and workmanship. Hayward warrants all accessories and replacement parts for the above-identified pool automation and chlorination products for a period of one (1) year. Accessories also include remotes, actuators, base stations, temperature sensors, flow switches and chemistry probes. Each of these warranties is not transferable and applies only to the original owner.

Hayward shall not be responsible for cartage, removal, repair or installation labor or any other such costs incurred in obtaining warranty replacements or repair.

Proof of purchase is required for warranty service. If written proof of purchase is not provided, the manufacturing date code will be the sole determinant of the date of installation of the product. To obtain warranty service or repair, please contact the place of purchase or the nearest Hayward authorized warranty service center. For more information on authorized service centers please contact the Hayward Technical Service Support Center (61 Whitecap Road, North Kingstown RI, 02852) or visit the Hayward web site at www.hayward.com.

WARRANTY EXCLUSIONS:

1. Material supplied or workmanship performed by others in process of installation.
2. Damage resulting from improper installation including installation on pools larger than the product rating.
3. Problems resulting from failure to install, operate or maintain the product(s) in accordance with the recommendations contained in the owners manual(s).
4. Problems resulting from failure to maintain pool water chemistry in accordance with the recommendations in the owners manual(s).
5. Problems resulting from tampering, accident, abuse, negligence, unauthorized repairs or alterations, fire, flood, lightning, freezing, external water, degradation of natural stone used in or immediately adjacent to a pool or spa, war or acts of God.
6. Use of a non-genuine Hayward replacement salt chlorination cell on any Hayward automation or chlorination product will void the warranty for that product.

The express limited warranty above constitutes the entire warranty of Hayward Pool Products with respect to its products and is in lieu of all other warranties expressed or implied, including warranties of merchantability or fitness for a particular purpose. In no event shall Hayward Pool products be responsible for any consequential, special or incidental damages of any nature. Some states do not allow a limitation on how long an implied warranty lasts, or the exclusion of incidental or consequential damages, so the above limitation may not apply to you. This warranty gives you specific legal rights, and you may also have other rights, which vary from state to state.

For further information or consumer
technical support, visit our website at
www.hayward.com



Hayward is a registered trademark and OmniHub is
a trademark of Hayward Industries, Inc. © 2023 Hayward Industries, Inc.

All other trademarks not owned by Hayward are the property of their respective owners. Hayward is not in any way
affiliated with or endorsed by those third parties. For patent information, refer to www.hayward.com/patents.

USE ONLY HAYWARD GENUINE REPLACEMENT PARTS